

Model 15S Servo Style Encoder

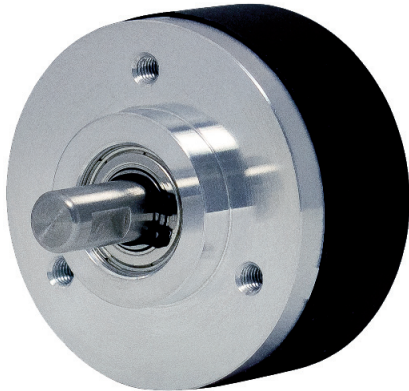

Ø38.0 mm

Features

- Very High Performance Economical Encoder
- Low Profile - Less Than 25.4 mm Height and 38 mm Diameter
- Extended Temperature Operating Ranges Available
- Up To 12 Pole Commutation Optional (for brushless motor control)

The Model 15S offers a high performance feedback solution in a low profile package, making the Model 15S ideal for commercial and light-duty industrial applications. This industry standard Size 15 (38mm diameter) encoder features a precision bearing set, sealing available to IP64, a durable stainless steel shaft, and a selection of servo, flange, and face mount options. The Model 15S may also be specified with features such as extended operating temperatures from -20° C to +120° C, or up to 12 pole commutation for brushless motor control. The Model 15S features our Opto-ASIC circuitry for a clean, reliable signal. It has a durable, yet economical design making it an ideal encoder for high precision OEM applications.

Common Applications

Servo Motor Control, Robotics, Medical Diagnostic Equipment, Speciality Assembly Machines, Digital Plotters, Printers, Typesetting Equipment

Model 15S Ordering Guide

Blue type indicates price adder options. Not all configuration combinations may be available. Contact Customer Service for details.

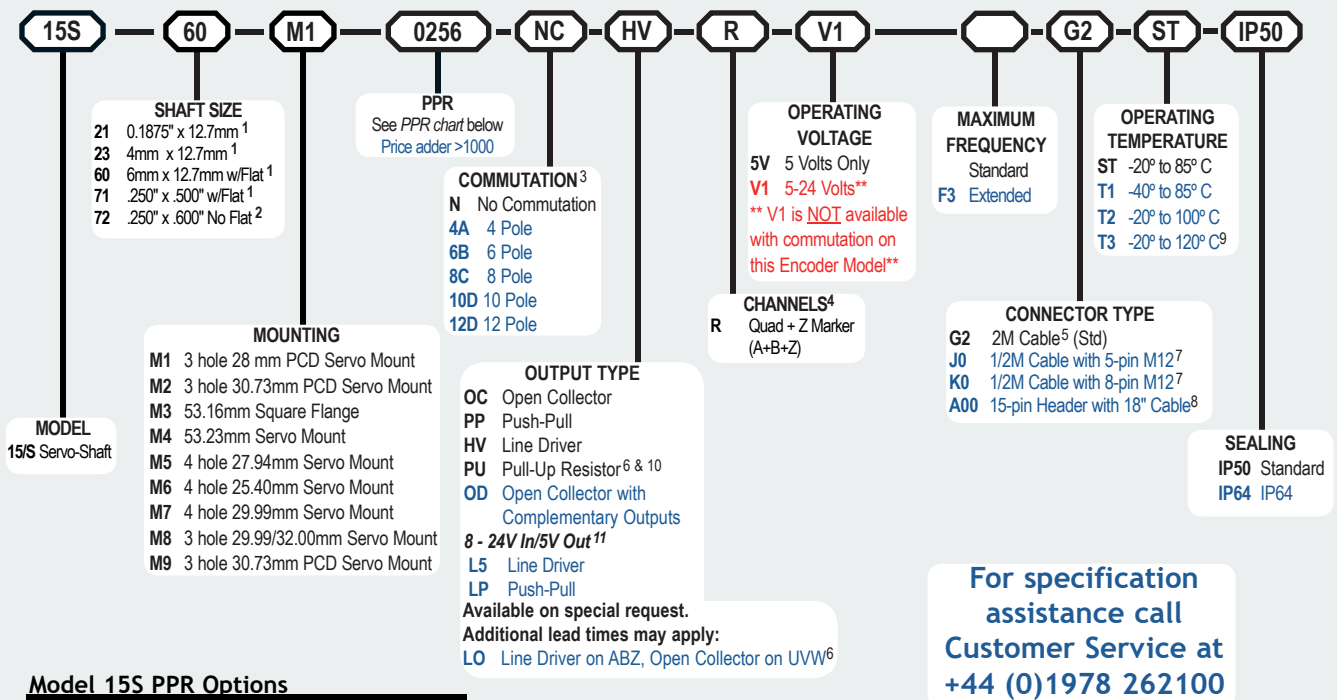

Model 15S PPR Options

| | | | |
|-----------------|------|------|--------|
| 0001 thru 0189* | 0198 | 0200 | 0250 |
| 0256 | 0300 | 0315 | 0360 |
| 0500 | 0512 | 0580 | 0600 |
| 0800 | 1000 | 1024 | 1200 |
| 1500 | 1800 | 2000 | 2048 |
| 2540 | 3000 | 3600 | 4000 |
| 5000 | 6000 | 7200 | 8192 |
| | | | 10,000 |

* Contact customer service for availability

New PPR values are periodically added to those listed. Contact Customer Service to determine all currently available values. Special disk resolutions are available upon request and may be subject to a one-time NRE fee.

NOTES:

- 1 Only available on models M1, M7 and M8 options - call sales for other available options.
- 2 Only available on models M2, M3, M4, M5, M6 and M9 - call sales for other available options.
- 3 Not available in all configurations, and not available with V1 Input Voltage. Contact Customer Service for availability.
- 4 Contact Customer Service for non-standard marker gating or phase relationship options.
- 5 For non-standard cable lengths contact sales for availability and cost.
- 6 With Input Voltage above 16 Vcc, operating temperature is limited to 85° C. Not available with A00 15 Pin Header option.
- 7 Not available with commutation. 5-pin not available with Line Driver (HV, OD, LO) outputs. Additional cable lengths available. Please consult Customer Service.
- 8 Pin Header available with 5 VDC Input Voltage, HV Line Driver and standard quadrature phasing only. Not available with CE Certification. IP50 sealing option only.
- 9 Only available with 5 Vcc Input Voltage.
- 10 Reverse Quadrature not available with PU output type.
- 11 Standard temperature only, Not available with Commutation.

Model 15S Servo Style Encoder

Model 15S Specifications

Electrical

| | |
|---------------------|--|
| Input Voltage..... | 5 Vcc \pm 10% Fixed Voltage 4.75 to 28 Vcc max for temperatures up to 85° C 4.75 to 24 Vcc for temperatures between 85° to 100° C <i>5V Only for Commutation Encoders</i> |
| Input Current..... | 140 mA max (65 mA typical) with no output load |
| Output Format..... | Incremental- Two square waves in quadrature with channel A leading B for clockwise shaft rotation, as viewed from the encoder mounting face. See <i>Waveform Diagrams</i> . |
| Output Types..... | Open Collector- 20 mA max per channel Push-Pull- 20 mA max per channel Pull-Up- Open collector with 2.2K ohm Pull-Up 20mA max per channel Line Driver- 20 mA max per channel (Meets RS 422 at 5 Vcc supply) |
| Index..... | Once per revolution. 401 to 10,000 PPR: Gated to output A 1 to 400 PPR: Ungated See <i>Waveform Diagrams</i> . |
| Max. Frequency..... | Standard Frequency Response is 200 kHz for PPR 1 to 2540 500 kHz for PPR 2541 to 5000 1 MHz for PPR 5001 to 10,000 Extended Frequency Response (optional) is 300 kHz for PPR 2000, 2048, 2500, and 2540 |
| Noise Immunity..... | Tested to BS EN61000-6-2; BS EN50081-2; BS EN61000-4-2; BS EN61000-4-3; BS EN61000-4-6, BS EN500811 |
| Symmetry..... | 180° (\pm 18°) electrical |
| Quad. Phasing..... | 90° (\pm 22.5°) electrical |
| Min. Edge Sep..... | 67.5° electrical |
| Accuracy..... | Within 0.017° mechanical or 1 arc-minute from true position. (for PPR>189) |
| Commutation..... | Up to 12 pole. Contact Customer Service for availability. |
| Comm. Accuracy..... | 1° mechanical |

Mechanical

| | |
|------------------------|--|
| Max Shaft Speed..... | 8000 RPM. Higher speeds may be achievable, contact Customer Service. |
| Shaft Material..... | Stainless Steel |
| Radial Shaft Load..... | 2.27 Kg max. Rated load of 0.91 Kg to 1.36Kg |
| Axial Shaft Load..... | 2.27 Kg max. Rated load of 0.91 Kg to 1.36Kg |
| Starting Torque..... | IP50: 3.531×10^{-4} Nm IP64: 2.825×10^{-3} Nm |
| Electrical Conn..... | 2M cable (foil and braid shield, 24 AWG conductors non-commutated, 28 AWG commutated), 5- or 8-pin M12 (12 mm) in-line connector with 2M cable (braid shield), 15-pin Header with 2M Cable |
| Weight..... | 100 grams typical |

Environmental

| | |
|---------------------|--|
| Operating Temp..... | -20° to +85° C for standard models -40° to +85° C for low temperature option -20° to +100° C for high temperature option -20° to +120° C for extreme temperature option |
| Storage Temp..... | -25° to +85° C |
| Humidity..... | 98% RH non-condensing |
| Vibration..... | 10 g @ 58 to 500 Hz |
| Shock..... | 80 g @ 11 ms duration |
| Sealing..... | IP50 standard; IP64 available |

Model 15S Standard Servo Mount (M1)

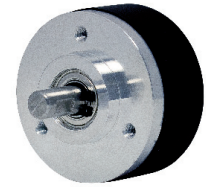
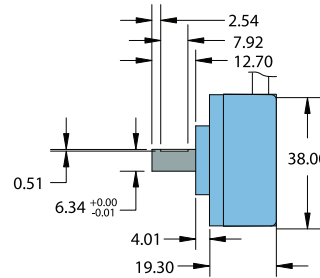
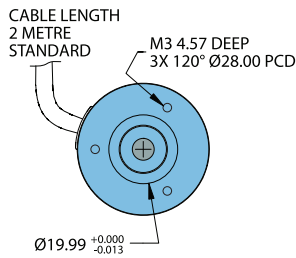

Model 15S Servo Mount M2 & M9*

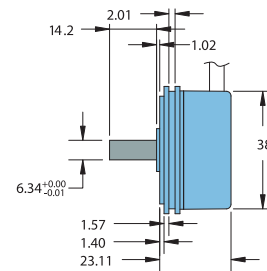
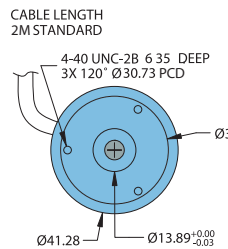

*M9 mount includes a 19.05mm boss



Model 15S Servo Mount (M5)

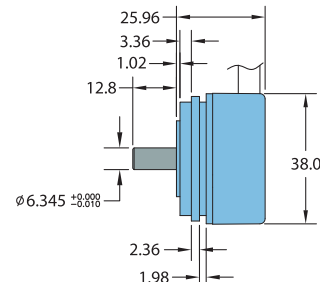
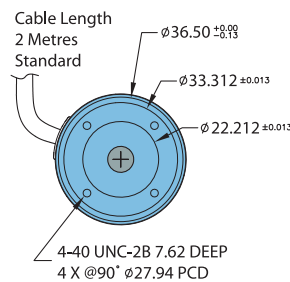

Model 15S Servo Mount (M6)

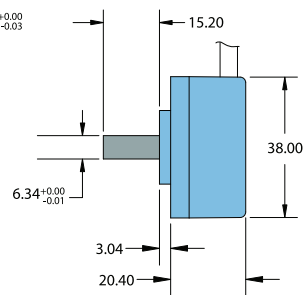
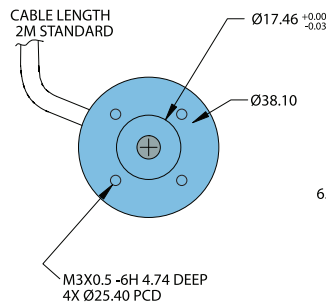

Model 15S Servo Mount (M7)

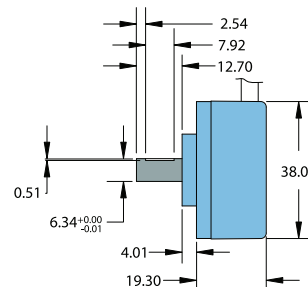
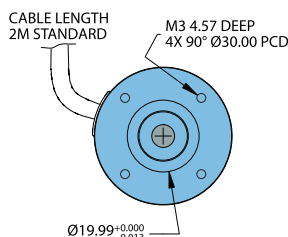

All dimensions are in mm with a tolerance of ± 0.127 mm or ± 0.254 unless otherwise specified

Model 15S Servo Style Encoder

Model 15S Standard Servo Mount (M4)

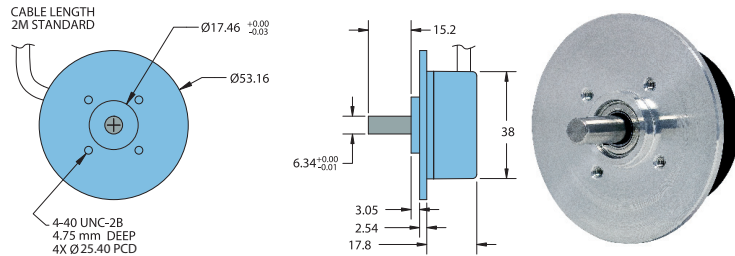

Waveform Diagram

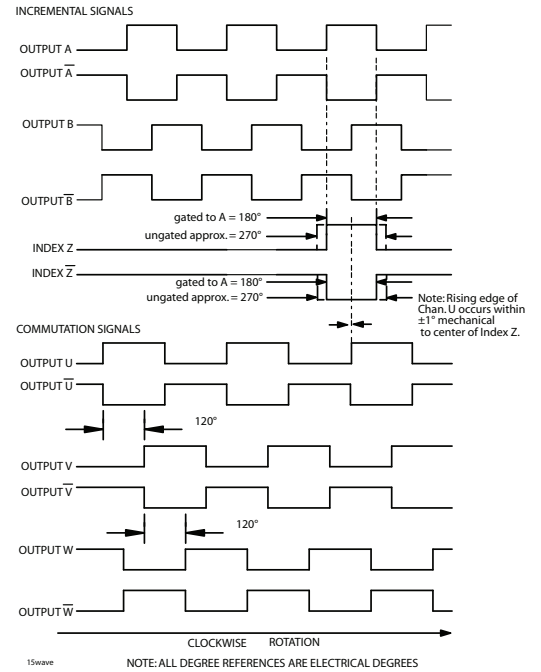

Model 15S Square Flange (M3)

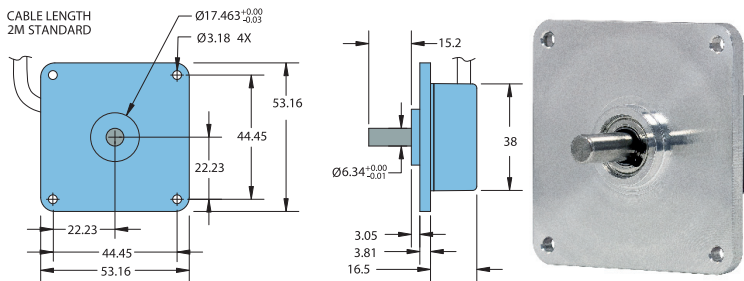

Model 15S Servo Mount (M8)

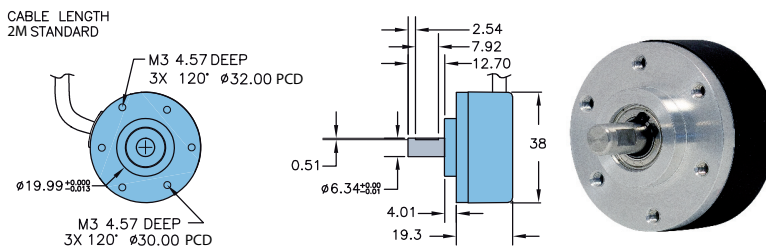

All dimensions are in mm with a tolerance of ± 0.127 mm or ± 0.254 unless otherwise specified

Wiring Table

| Function | Gland Cable† Wire Color | 5-pin M12** PP,OC,PU | 8-pin M12** HV,OD | 8-pin M12** OC,PP,PU | 15 Pin Header HVL5 |
|----------|----------------------------|----------------------------|-------------------------|----------------------------|--------------------------|
| 0 Volts | Black | 3 | 7 | 7 | 1 |
| +VCC | White | 1 | 2 | 2 | 2 |
| A | Brown | 4 | 1 | 1 | 4 |
| A' | Yellow | -- | 3 | -- | 3 |
| B | Red | 2 | 4 | 4 | 6 |
| B' | Green | -- | 5 | -- | 5 |
| Z | Orange | 5 | 6 | 6 | 7 |
| Z' | Blue | -- | 8 | -- | 8 |
| U | Violet | -- | -- | -- | 10 |
| U' | Gray | -- | -- | -- | 9 |
| V | Pink | -- | -- | -- | 14 |
| V' | Turquoise | -- | -- | -- | 13 |
| W | Red/Green | -- | -- | -- | 12 |
| W' | Red/Yellow | -- | -- | -- | 11 |
| Shield | Bare ¹ | Case | Case | 8 | -- |

*CE: Cable shield (bare wire) is connected to internal case.
†Standard cable is 24 AWG conductors with foil and braid shield.
**CE: Shield is connected to connector case unless otherwise specified.

Connector Pin-Outs

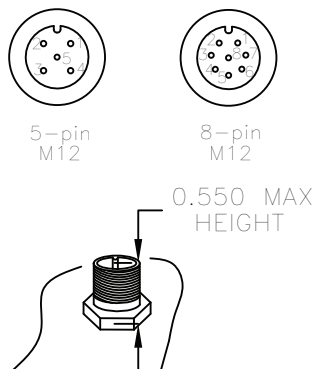

15-pin Header

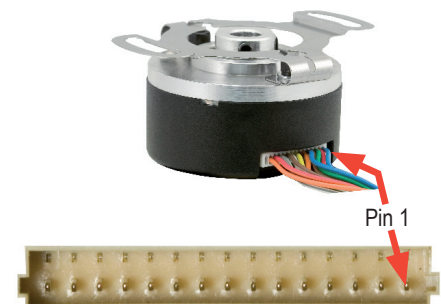

Replacing your encoder has never been simpler.

Model 15S

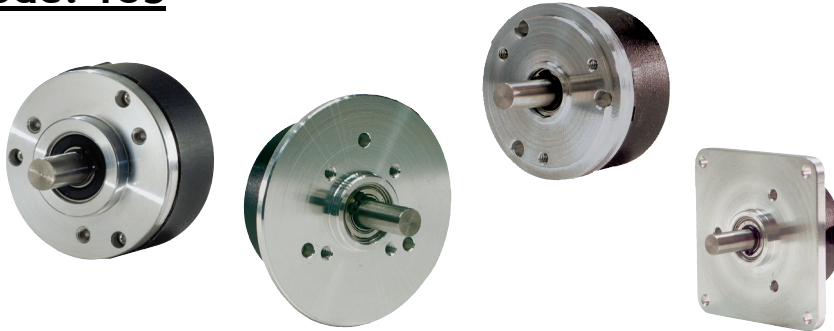

Our Model 15S has more mounting face options than any other 38mm shaft encoder. A variety of bosses and bolt hole patterns will provide cross-reference adaptability like no other encoder.

Model 15T/15H



Models 15T and 15H are the superior choice for your servo or stepper motor application. Endurance in High Temperatures, High Resolution Performance, Commutation, and Flexible Mounting Options make the 15T/H an unbeatable encoder.

Cross References:

The Model 15 can be crossed to many encoders- this is NOT a complete list. Please contact Customer Service for additional offerings and to ensure complete and accurate cross-referencing.

| Competitors Model | 15S Mounting Face |
|---------------------|-------------------|
| Automation Dir TRDS | M1 |
| DRC 23 | M4 |
| DRC 77L | M4 |
| DRC M2 | M3, M4 |
| Dynapar E14 | M5 |
| Dynapar E23 | M6 |
| Nemicon OEW | M7 |
| Nemicon OVW | M1 |
| Renco RS15 | M6 |
| Sumtak IRS3 | M1 |
| Tamagawa OIS38 | M1 |
| Tekel TK-15 | M6 |
| Omron E6B2 | M8 |
| Sumtak LBL | M9 |

| Competitors Model | 15T/H Flex Mount PCD |
|-------------------|----------------------|
| DRC 730 | FF |
| DRC 731 | FF |
| DRC H15 | SF |
| DRC T23 | FF |
| Dynapar M14 | SC |
| Dynapar M15 | SF |
| Dynapar M21 | SF |
| Dynapar F14 | SB, SF |
| Renco RHS15 | SF |
| Renco RCM15 | SC |
| Sumtak IRH3 | SD |
| Sumtak IRT3 | SD |
| Sumtak LBK/LDA | FF, SF |
| Turck 8.3720 | SF |

For specification assistance call Customer Service at +44 (0)1978 262100