

## Dynisco SPX Industrial (2280/2281) Series

SMART GENERAL PURPOSE PRESSURE SENSORS



### Description

The Dynisco SPX228X is an all welded construction smart industrial 4-20mA pressure transmitter designed for use in hazardous locations. Models are available in PSIG, PSIA, and PSIS. Optional pressure fittings and electrical terminations are available.

### Features

- 4-20mA loop-powered output
- +/- 0.25% accuracy available
- Wide selection of pressure ranges available
- Turndown 3:1
- Configurations available for use in hazardous locations
- Remotely configurable via HART™
- Precise, repeatable pressure measurements
- Output supplied directly to DSC or PLC
- Meets CE requirements
- CE ATEX Intrinsically Safe Approved
- FM Explosion Proof Approved
- CSA Explosion Proof Approved
- SIL 2 Certified (Pressure Output)
- PL'c' Certified (Relay Output)
- Additional approvals are available

Performance Characteristics SPX2280 & SPX2281	
Output	4 - 20 mA, with optional HART™
Input Voltage	16 - 36 Vdc (Std); 16 - 30 Vdc (ATEX IS)
Accuracy	2280 ± 0.5% 2281 ± 0.25%
<small>Accuracy is defined as the combined error expressed as a percentage of full scale output with the specifications of: Electronics ambient temperature, capillary of &lt;= 36"; DyMax coated 15-5 SST diaphragm; Best Straight Line (BSL) %FS, per ISA-37.1 Consult Factory for availability and specifications of other configurations.</small>	
Repeatability	±0.1%
Rangeability	3:1 Turndown
Over Pressure	1.5 x FSO; 250 - 30,000 psi 1.2 x FSO; 35,000-72,500 psi
Zero Balance Adjustment Range	±5% FSO Maximum
Load Resistance	500 Ω @ 24 Vdc, 1,000 Ω @ 36 Vdc
Electronics Ambient Temperature	70°F (20°C)
Operating Temperature	-20 to 185°F (-29 to 85°C)
Compenstated Temperature Range	0 to 150°F (-18 to 65°C)
Span Shift (Temp Change)	All Models: 0.02% F.S./°F max (0.04% F.S./°C max)
Zero Shift (Temp Change)	All Models: 0.01% F.S./°F max (0.02% F.S./°C max)
Burst Pressure	250 psi: 10 X FSO 500 - 3,000 psi: 5 X FSO 5,000 - 10,000 psi: 3 X FSO 15,000 - 30,000 psi: 2.5 X FSO 40, 000 - 72,500 psi: 1.5 X FS

Mechanical Characteristics	
Standard Wetted Parts	15-5 PH & 17-4 PH SST
Approvals & Certifications	
CE ATEX IS	
SIL 2 (pressure output) & PL'c' (relay output)	
FM & CSA Explosion Proof	
Additional Approvals are Available	

## Ordering Guide for Models SPX2280 & SPX2281<sup>1</sup>

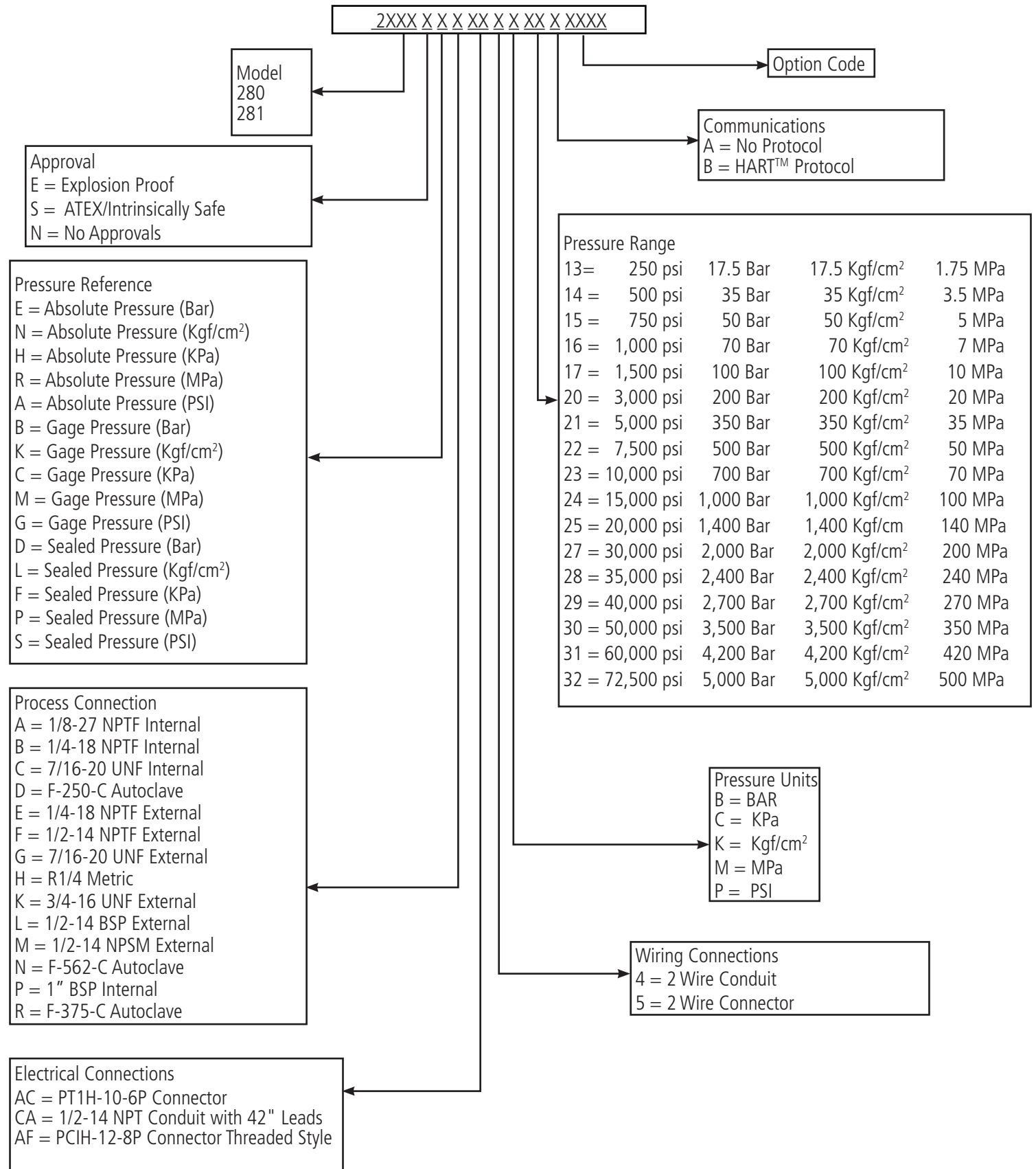

<sup>1</sup> Other configurations are available. Please consult factory.

# Drawing SPX2280

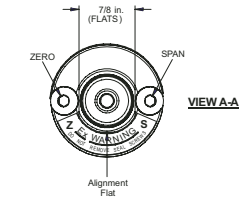

Cable Wiring		
Color	Function	
RED	E+	
BLACK	E-	
GREEN	GROUND	
ORANGE	Rel +	
BLUE	Rel -	

- A Ftg = 5 - 20,000 PSIG
- B Ftg = 5 - 20,000 PSIG
- C Ftg = 5 - 10,000 PSIG
- D Ftg = 5 - 60,000 PSIG
- Where; -R Ftg = 5 - 60,000 PSIG

## Fitting - R (and Fittings A thru D)

(PRESSURE LISTED ABOVE)

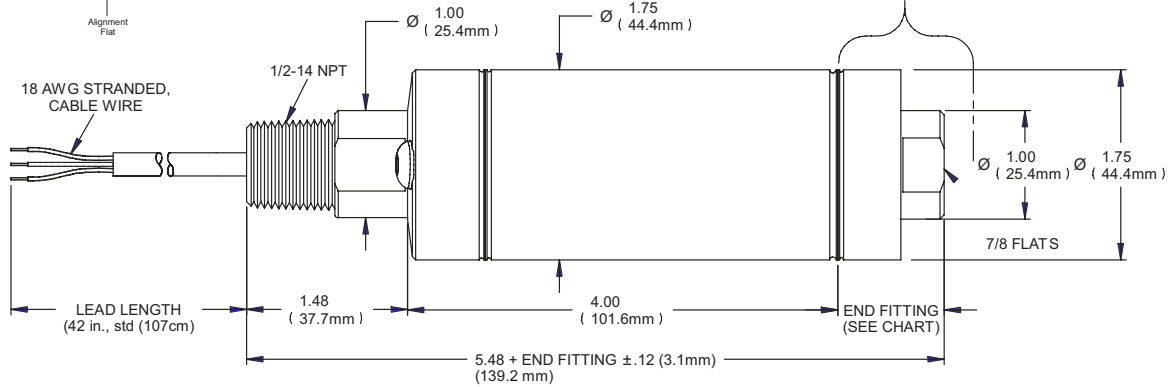

**Fitting - E**  
(5-10,000 PSIG)

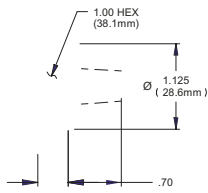

**Fitting - F**  
(5-10,000 PSIG)

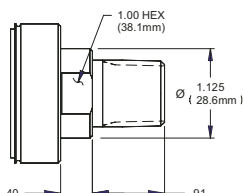

**Fitting - G**  
(5-7,500 PSIG)

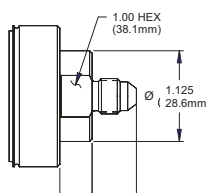

**Fitting - H**  
(5-10,000 PSIG)

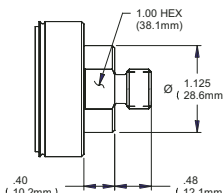

**Fitting - L**  
(1,000- 40,000 PSIG)

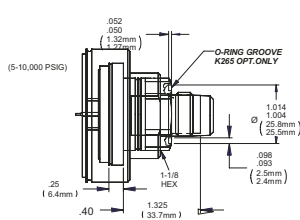
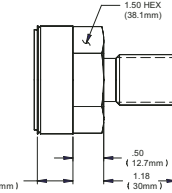

**Fitting - M**  
(1,000- 60,000 PSIG)

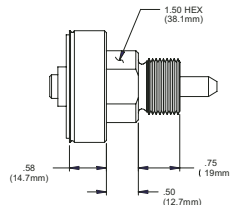

**Fitting - N**  
(1,000- 60,000 PSIG)

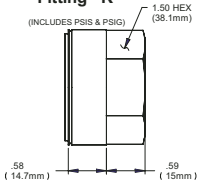

**Fitting - K**  
(INCLUDES PSIS & PSIG)

**Fitting - P**  
(1,000- 30,000 PSIG)

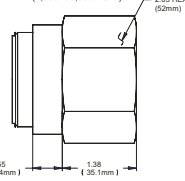

### Pressure Fitting Quick Reference

Suffix	DESCRIPTION	TYPE
-- A	1/8-27 NPTF	INT. Thread
-- B	1/4-18 NPTF	
-- C	MS33649-4	
-- D	F-250-C	Conduit fgt
-- E	1/4-18 NPTF	
-- F	1/2-14 NPTF	EXT. Thread
-- G	MS33656-4	
-- H	R 1/4	
-- K	3/4-16 UNF	EXT. Thread
-- L	1/2-14 BSP	
-- M	1/2-14 NPSM	INT. Thread
-- N	F-562-C	
-- P	1" BSP	
-- R	F-375-C	

# Drawing SPX2281

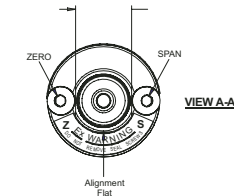

3 - Conductor	RED	E+
	BLACK	E-
5 - Conductor	GREEN	GROUND
	ORANGE	Real +
	BLUE	Real -

-A Ftg = 5 - 20,000 PSIG  
 -B Ftg = 5 - 20,000 PSIG  
 -C Ftg = 5 - 10,000 PSIG  
 -D Ftg = 5 - 60,000 PSIG  
 Where: -R Ftg = 5 - 60,000 PSIG

## Fitting - R (and Fittings A thru D) (PRESSURE LISTED ABOVE)

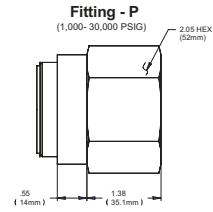
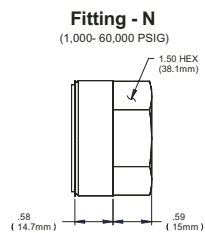
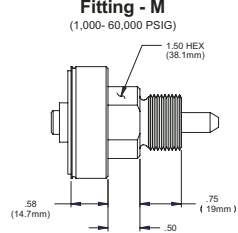
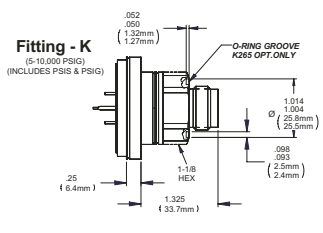
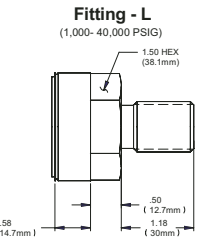
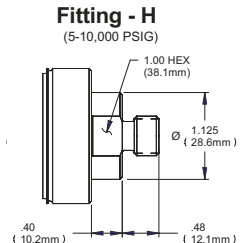
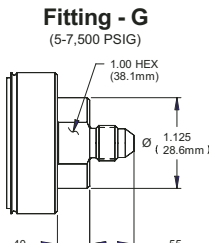
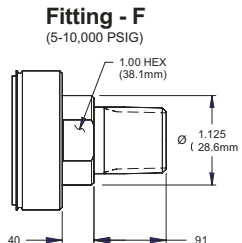
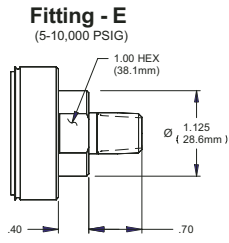
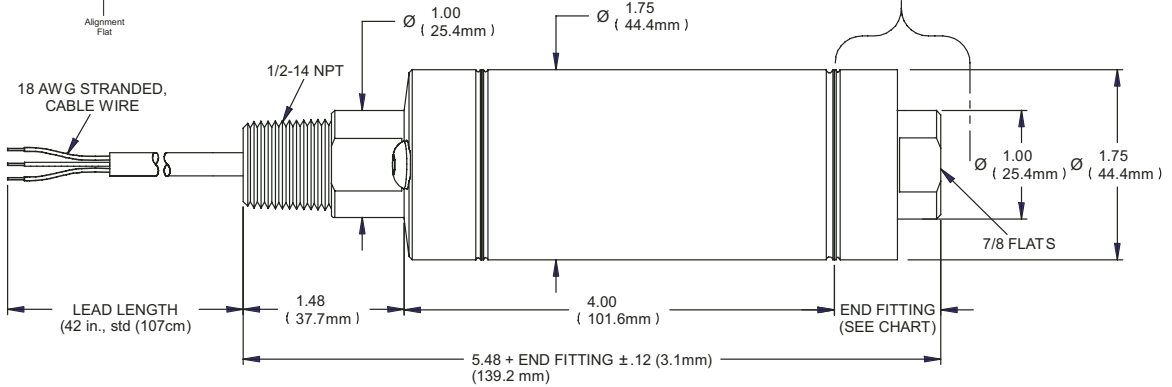

Pressure Fitting Quick Reference		
Suffix	DESCRIPTION	TYPE
-- A	1/8-27 NPTF	INT. Thread
-- B	1/4-18 NPTF	
-- C	MS33649-4	
-- D	F-250-C	
-- E	1/4-18 NPTF	Conduit fgt
-- F	1/2-14 NPTF	
-- G	MS33656-4	
-- H	R 1/4	EXT. Thread
-- K	3/4-16 UNF	
-- L	1/2-14 BSP	
-- M	1/2-14 NPSM	
-- N	F-562-C	INT. Thread
-- P	1" BSP	
-- R	F-375-C	

REV	ECO	BY	APP	DATE
A	46553	TP	LEB	07/29/16 R

000652

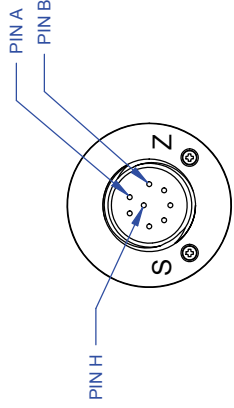

8 - PIN PC  
O-RING WITH PUSH BUTTONS  
PCIH-12-8P

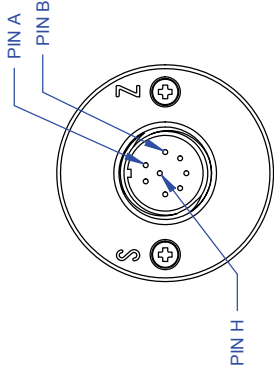

8 - PIN PC  
WELDED WITH PUSH BUTTONS  
PCIH-12-8P

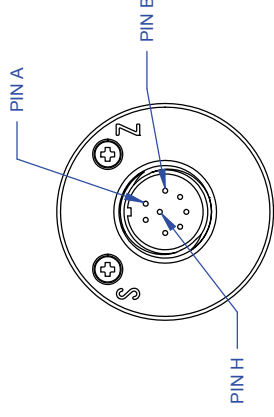

8 - PIN PC  
WELDED WITH HALLS  
PCIH-12-8P

GUARDIAN CONNECTOR WIRING	
PIN	FUNCTION
A	POWER +
B	SIGNAL -
C	POWER -
D	NO CONNECTION
E	Rcal -
F	Rcal +
G	RELAY CONTACT
H	RELAY CONTACT

NOTE:  
1. THESE CONNECTOR OPTIONS ARE AVAILABLE ON MOST OF THE CONFIGURATIONS SHOWN ON THE PREVIOUS SHEETS.

TOLERANCES UNLESS OTHERWISE SPECIFIED:  
 1. PLACE DECIMAL ± .005  
 2. FRACTIONS ± 1/32  
 3. DRILLS < 0.5 DIA. ± .002 > 0.5 DIA. ± .003  
 4. ANGLES ± 0.5° MAX.  
 5. EDGES R .006 OR CHAMFER MAX.  
 6. PART TO BE FREE OF BURRS  
 7. ALL DIMENSIONS ARE IN INCHES.

TITLE		GUARDIAN SERIES CONNECTORS	
DRAWN	TP	DATE	7/27/16
CHECKED		DATE	
APPROVED	LEB	DATE	7/27/16
FINISH	63		

SIZE		DWG. NO.		REV	
B		000652		A	
SCALE NONE SHEET 1 OF 1					

EXCEPT AS MAY BE OTHERWISE PROVIDED BY CONTRACT, THESE DRAWINGS AND SPECIFICATIONS ARE THE PROPERTY OF DYNISCO. ANY REPRODUCTION, REPRODUCTION OR COPIED, OR USED AS THE BASIS FOR THE MANUFACTURE OR SALE OF APPARATUS WITHOUT PERMISSION.



©2016. Dynisco reserves the right to make changes without notice.  
Refer to [www.dynisco.com](http://www.dynisco.com) for access to Operator Manual and other support documentation.  
PN: DSSPX228081SERIES  
REV: 0716  
ECO: 46503



[www.dynisco.com](http://www.dynisco.com)

#### Dynisco

38 Forge Parkway  
Franklin, MA 02038  
USA

Hotline 1-800-Dynisco  
www.dynisco.com  
Phone +1 508 541 9400  
Fax +1 508 541 6206  
Email [infoinst@dynisco.com](mailto:infoinst@dynisco.com)

#### Dynisco Europe, GmbH

Pfaffemstr. 21 Phone +49 7131 297 0  
74078 Hellbronn Fax +49 7131 297 166  
Germany Email [dyniscoeurope@dynisco.com](mailto:dyniscoeurope@dynisco.com)

#### Dynisco Shanghai

Building 7A, No. 568 Phone +86 21 34074072-819  
Longpan Rd Malu Toll Free +86 400 728 9117  
Jiading, 201801 China Fax +86 21 34074025