



# USER MANUAL

## ATR131-1D

### Temperature Controller

#### 1. General Description



ATR131 is a digital temperature controller designed to control one or two of our thermoelectric air conditioners or cold plates. The model we stock is 12V input and has one relay output to thermoelectric cooler/s.

Available by special order or three relays to control thermoelectrics, defrosting and a fan. Memory cards are available for configurations in series or for system logs.

#### 2. Ordering Codes

ATR131-	X	X	X	
Probes	1			1 NTC probe, 1 relay
	3			1 NTC probe + 1 evaporator probe, 3 relays
		D		12Vac ±10% 50/60Hz
Power Supply		A		24Vac ±10% 50/60Hz
		B		230Vac ±10% 50/60Hz
		C		115Vac ±10% 50/60Hz
Serial			T	Rs485 with Modbus RTU slave protocol.

#### 3. Dimensions and Installation

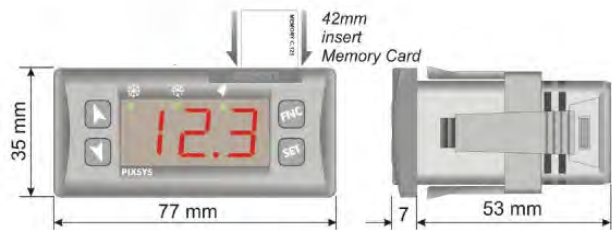
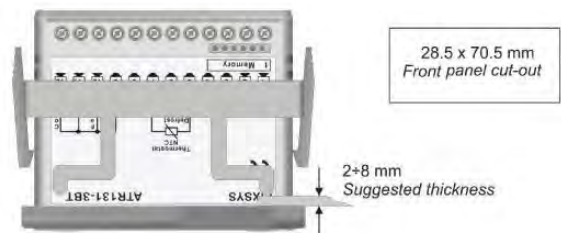

#### 4. Operations

Controlling temperature is always subject to hysteresis: the thermoelectric cooling stops when the set-point is reached and starts up again when the temperature exceeds the high set-point plus the hysteresis value.

Additional Programmable features for special order units: defrost frequency, type of time keeping and max defrost time. The high and low temperature alarms can be excluded for a set amount of time after defrosting or starting the device. There are also various solutions to protect against start up too close to each other (start delay, minimum off time and minimum time between the two successive activations).



# USER MANUAL

## ATR131-1D

### Temperature Controller

#### 5. Electrical Connections

The ATR 131 is fitted with screw terminals suitable for wires with a maximum diameter of 2.5mm<sup>2</sup>. Make sure that the power supply voltage corresponds to the power supply supported by the device. The 2 wires of the NTC probe do not have polarity. It is good safety feature to distinguish the main power line from the probe power line.

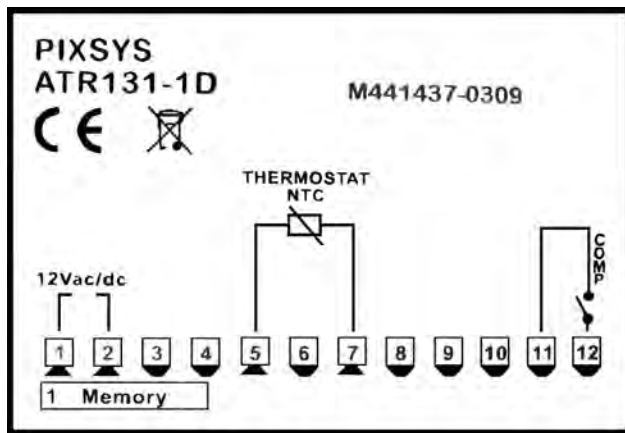

#### 6. Front Panel

LED	Description
	Indicates the status of the cooler. Blinks when the set-point is displayed.
	On when defrosting.
	On when the alarm is enabled.

	Press 3 to enter password (123) and start configuration. Press when configuring to save parameters and exit.
	Press to view setpoint. If pressed for 3 seconds the manual defrost feature starts. When configuring, if pressed together with the arrows, it allows to change parameters. When entering password the next digit starts blinking.
	Change setpoints. When configuring, the parameters scroll; if pressed together with the  key, the parameter displayed at that moment is changed. When entering password they change the digit.

#### 7. Technical Data

BOX:	32x74(front)x58mm
POWER SUPPLY:	ATR131-xD: 12Vac ±10% 50/60Hz.
CONSUMPTION:	2W
DISPLAY:	3 red digit, Green LEDs, decimal point
ENVIRONMENTAL CONDITIONS:	0...40°C, 0...95rH%
INPUTS:	NTC 10K (B value 3435K)
PRECISION:	0.5% ± 1digit
ACQUISITION SPEED:	75ms DISPLAY
ADJUSTMENT:	ON/OFF with hysteresis
OUTPUT:	compressor: 10A relay
PROTECTION:	IP54 frontal, IP30 BOX, IP20 terminal board
CONFIGURATION:	Parameters protected by password (123) and memory card for production in series.

#### 8. Error messages

If the system malfunctions, the controller takes the output of the compressor (Thermoelectrics Curcuit) as set in parameter

and alerts the presence of an error. For the various error signals see the table below:

























	Cause	What to do
	Error in programming EEPROM cell.	Call assistance
	Wrong configuration data: Possible loss of device settings	Check if the configuration parameters are correct.
	NTC cell probe damaged or temperature outside limit.	Check probe connection and condition.





































9. Table of Configurable Parameters

To configure press the  key for 3 seconds and enter password 123 with the arrow keys and move

the blinking digit with the  key.

To scroll through the parameters press the up or down arrows. To change them press the  key and the arrow keys.

No.	Display	Description	Range
1		<b>(compressor hysteresis):</b> Set the hysteresis in the calculation of the intervention thresholds for relay output of the compressor.	<b>-19.9..30.0°C (°F)</b> Default: 2.0°C.
2		<b>(Lower Set-point)</b> Lowest programmable value. The set-point may not be set under this value.	<b>-40..  °C (°F)</b> Default: -40°C
3		<b>(Higher Set-point)</b> Highest programmable value. The set-point may not be set above this value.	<b>..210°C (°F)</b> Default : 40°C
4		<b>(Defrost Time)</b> Enter the interval length between each defrost.	<b>1..31 hours.</b> Default: 6 hours.
5		<b>(Defrost Count)</b> Select how to operate the interval between each defrost.	<b>:(Compressor Time On)</b> Only the operating time of the compressor is timed. <b>:(Real Time)</b> The interval between the beginning of defrosting is the actual elapsed time: The time is always the same. (Default) <b>:(Stop Compressor Defrost)</b> Defrost whenever the compressor stops. <b>:(Free)</b> The compressor continues to regulate the SET regardless of defrost.
6		<b>(Defrost Delay)</b> Delay time for defrost.	<b>0..60 minutes</b> Default: 0 minutes
7		<b>(Defrost block Cell)</b> If temperature of cell is above this threshold, the defrost action will not start	<b>-10..60°C (°F)</b> Default: 10°C.
8		<b>(Max Defrost Time)</b> Duration of defrost.	<b>1..99 minutes</b> Default: 30 minutes
9		<b>(Defrost Start-up)</b> Allows to defrost or not when the device is turned on	 : Default: 
10		<b>(Defrost visualization)</b> Select the display view during defrost.	 : Continue view of probe.  : Display last temperature before defrost.  : view  .
11		<b>(Compressor State Error)</b> Select the compressor status if the cell probe fails.	  : Default:

12		<b>(Compressor protection Selection)</b> Select the type of protection against high frequency compressor activation.	 :( <b>No Protection</b> ) No protection  :( <b>Delay On</b> ) Activation delay (default).  :( <b>Delay Off</b> ) Minimum time to stop compressor.  :( <b>Delay Between</b> ) Minimum time between compressor activations.
13		<b>(Compressor Time Protection)</b> Set the duration of the above parameter.	<b>0..15 minutes</b> Default: 0 minutes
14		<b>(Drainage Time)</b> Set the time the compressor is locked after defrost.	<b>0..99 minutes</b> Default: 0 minutes
15		<b>(Set-point Protection)</b> Allows/prevents modifications of Set-point by the User	 :( <b>Free</b> ) No protection, Set-point can be modified by arrow keys (Default)  :( <b>Two Hands</b> ) To modify Set-point it is necessary to press  key + one arrow key  :( <b>Lock</b> ) User cannot modify Set-point via keyboard
16		<b>(Input 2 )</b> Select operation of digital input (Pins 5-6)	 :( <b>Disable</b> ) Digital input disabled. (Default)  :( <b>Regulation Type</b> ) Cooling action if digital input open, otherwise heating (see  ).  :( <b>2 Thresholds Switch</b> ) Regulation on SET1 if open, otherwise on SET2
17		<b>(Alarm Type)</b> Type of alarm related to  and  .	 :( <b>Deviation Alarm</b> ) Alarm thresholds are given by SET +  and SET -  . (Default).  :( <b>Absolute Alarm</b> ) Alarm thresholds are given by parameters  and 
18		<b>(High Alarm)</b> Set the max temperature when the alarm signal goes off. Threshold is given by parameter  .	<b>-40..90°C (°F)</b> Default: 5°C.
19		<b>(Low Alarm)</b> Set the min temperature when the alarm signal goes off. Threshold is given by parameter  .	<b>-40..90°C (°F)</b> Default: 5°C.
20		<b>(Alarm Hysteresis)</b> Set the hysteresis in the calculation of the intervention thresholds of the alarms	<b>0.5..50.0°C (°F)</b> Default: 2.0°C.
21		<b>(Alarm Delay Start-up)</b> Set the time for deactivating alarms after turning the device on.	<b>0..10 hours.</b> Default: 2 hours.
22		<b>(Alarm Delay Defrost)</b> Set the time for deactivating alarms after defrost.	<b>0..10 hours.</b> Default: 1 hour.
23		<b>(Output Delay Start-up)</b> Set the time for deactivating outputs after turning the device on.	<b>0..99 minutes</b> Default: 0 minutes
<b>No.</b>	<b>Display</b>	<b>Description</b>	<b>Range</b>
24		<b>(Visualization)</b>	 :( <b>1 Probe No Decimal</b> )



# USER MANUAL

## ATR131-1D

### Temperature Controller

		Set visualization of temperature with/without decimal point	View cell probe without decimal point (Default) <input type="checkbox"/> <b>IPd</b> : <b>(1 Probe Decimal)</b> View cell probe with decimal point
25	<input type="checkbox"/> <b>acA</b>	<b>(Offset Calibration)</b> Correct the offset of cell probe (add/subtract degrees from displayed value)	<b>-19.9.0.9°C</b> Default: 0.0°C
26	<input type="checkbox"/> <b>dEC</b>	<b>(Degree)</b> Select type of degree	<input type="checkbox"/> <b>°C</b> : Celsius degrees (Default) <input type="checkbox"/> <b>°F</b> : Fahrenheit degrees
27	<input type="checkbox"/> <b>rEE</b>	<b>(Regulation Type)</b> Type of control/regulation	<input type="checkbox"/> <b>COO</b> : <b>Cool</b> (Default) <input type="checkbox"/> <b>HEA</b> : <b>Heat</b>
28	<input type="checkbox"/> <b>rAn</b>	<b>(Range)</b> Measuring range for the sensor	<input type="checkbox"/> <b>LoU</b> : <b>(Low)</b> Range -40...50°C. (Default) <input type="checkbox"/> <b>HiD</b> : <b>(High)</b> Range 0...100°C.
29	<input type="checkbox"/> <b>uSn</b>	<b>(User Menu)</b> Select if parameters 1 and 27 may be modified from user menu.	<input type="checkbox"/> <b>OFF</b> : Parameters 1 and 27 cannot be modified from user menu (Default) <input type="checkbox"/> <b>CHY</b> : Parameter 1 can be modified <input type="checkbox"/> <b>rEE</b> : Parameter 27 can be modified <input type="checkbox"/> <b>ALL</b> : Parameters 1 and 27 can be modified from user menu