

**Technical details**

<b>Connection</b>	G1/4
<b>Temperature range</b>	-10°C ... +70°C
<b>Medium</b>	Filtered, oil-free and dried compressed air according to ISO 8573-1:2010, Class 7:2:4, instrument air, free of aggressive additives. Alternatively the pressure dew point must be at least 10°C below lowest occurring ambient temperature.
<b>Materials</b>	Body: Al (anodized), plastic, seals: NBR, inner parts: Al, steel and plastic
<b>Protection</b>	IP 65 according to EN 60529

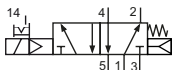

Electrically operated spool valve. The manual override is detent/ non-detent. It is operated manually or by screwdriver.

**5/2-way valves**

86-MV-5-24-511-xxx  
5/2-way, single solenoid, mechanical spring return and air spring return

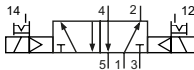

86-MV-5-24-520-xxx  
5/2-way, double solenoid

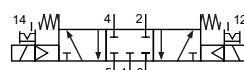
**5/3-way valves**

86-MV-5-24-530-xxx  
5/3-way, center position closed

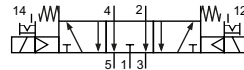

86-MV-5-24-533-xxx  
5/3-way, center position exhausted

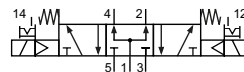

86-MV-5-24-534-xxx  
5/3-way, center position pressurized

Please complete: xxx = electrical option

**Electrical options**

Nominal voltage	Power consumption	Specifics	Plug connection* <sup>1</sup>	-XXX Manual override on same side of ports 2 and 4
24 V DC	3 W		Form B industrial norm	-M42
220 V AC	3.5 VA		Form B industrial norm	-M57

\*<sup>1</sup> Plug socket with integrated LED are part of delivery

**Technical data**

Model-no.:	86-MV-5-24-511	86-MV-5-24-520	86-MV-5-24-530	86-MV-5-24-533	86-MV-5-24-534
<b>Operating pressure (bar)</b>	1.5...8	1.5...8	1.5...8	1.5...8	1.5...8
<b>Nominal size (mm)</b>	6	6	5	5	5
<b>Flow rate (NI/min)</b>	1350	1350	980	980	980
<b>Response time (ms) at 6 bar</b>	20	20	20	20	20
<b>Weight (kg)</b>	0.290	0.400	0.460	0.460	0.460

# Series 86-MV-5-24

## Dimensions

### 86-MV-5-24-511

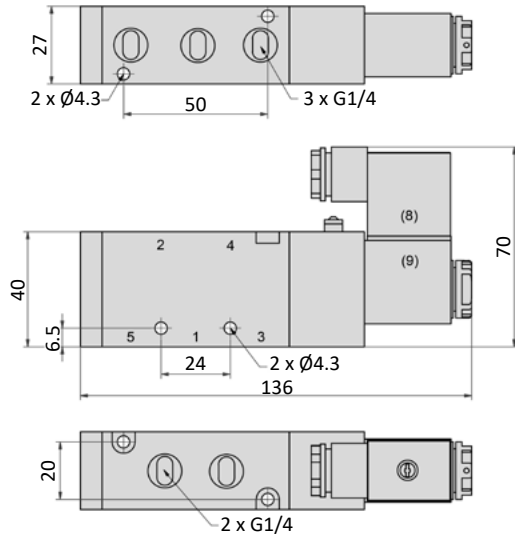

- 1 = pressure inlet
- 2,4 = outlets
- 3,5 = exhausts

Plug socket can be repositioned by 180°.  
Solenoid coil can be repositioned by 4 x 90°.

### 86-MV-5-24-520

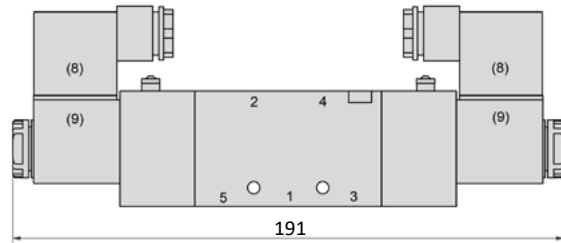

### 86-MV-5-24-53x

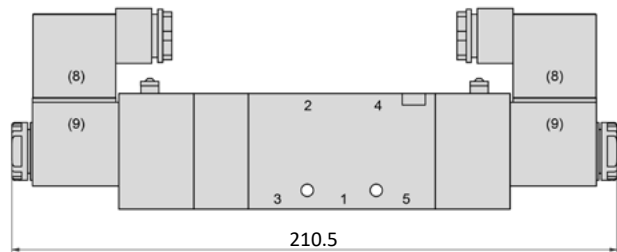

## General information

The 86-PRS manifolds are suitable for the 86-MV-5 valve series.  
Blind plates 86-PRS-xxx-V are available for blank stations.  
All mounting screws and o-rings are included.

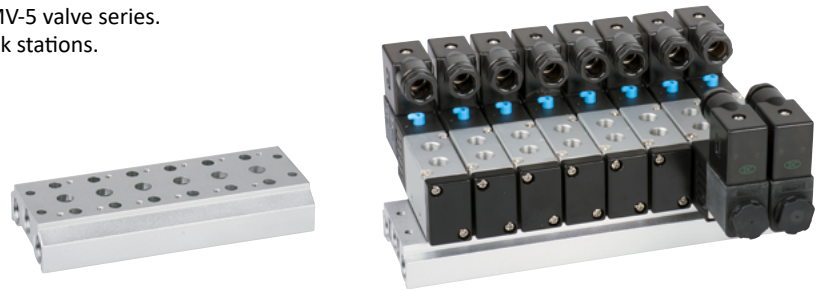

## Order code

Series		Number of stations	
86-PRS-***-**		02...20	
Size		Size	Standard
MVY	for series 86-MVY-18	MVY	04, 06, 08, 10, 12
100	for series 86-MV-5-18	100	02, 04, 06, 08, 10, 12, 14, 16
200	for series 86-MV-5-28, 86-MV-5-14	200	02, 04, 05, 06, 08, 10, 12, 14, 16
300	for series 86-MV-5-24, 86-MV-5-38	300	02, 04, 06
400	for series 86-MV-5-12	400	02, 04

## Dimensions

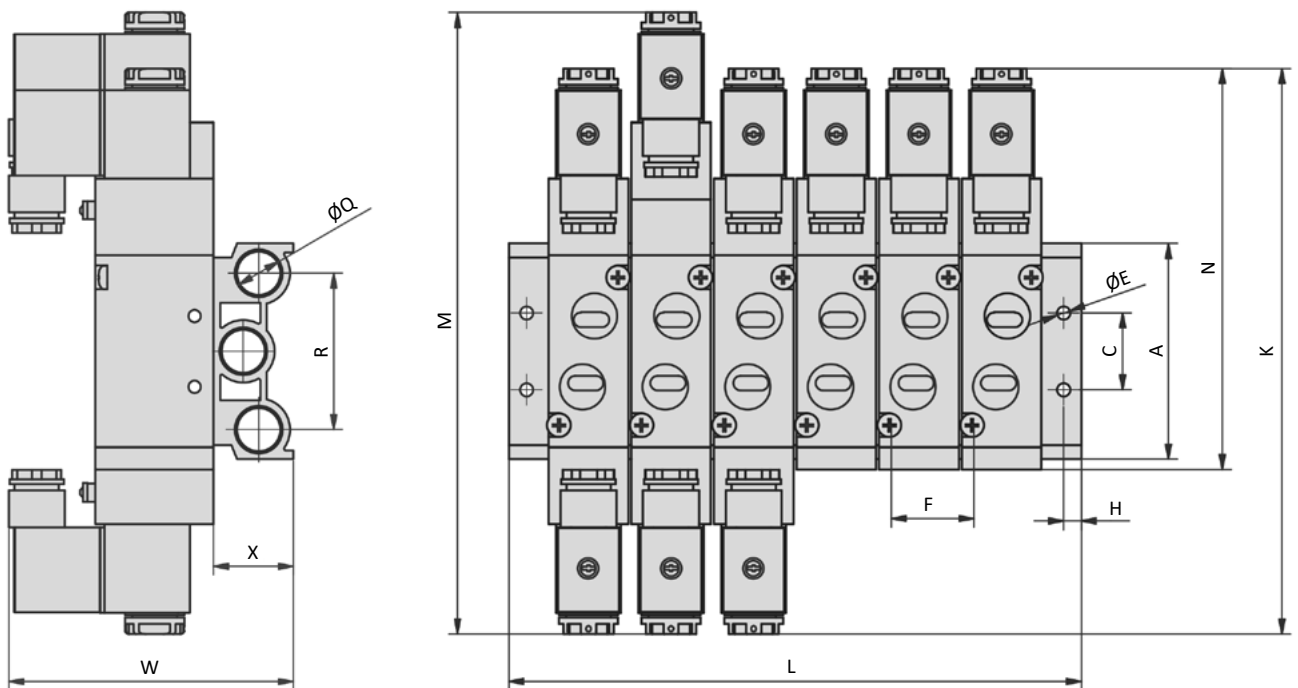

Model-no.:	A	C	Ø E	F	H	K	L	M	N	Q	R	W	X
86-PRS-MVY-xx	60	20	4.2	16	5	119	(xx-1)*16 + 34	132	92	G1/4	41	57	26.5
86-PRS-100-xx	58	20	4.2	19	5	140	(xx-1)*19 + 38	155	98	G1/4	40	77	22
86-PRS-200-xx	59	21	4.3	23	6	170	(xx-1)*23 + 46	189	116	G1/4	43	90	22
86-PRS-300-xx	75	26	4.5	28	6	189	(xx-1)*28 + 54	208	134	G3/8	53	98	27
86-PRS-400-xx	98	32	5.5	35	7	222	(xx-1)*35 + 63	243	168	G1/2	68	112	36

xx = number of stations

## Plug sockets

### Form B industrial norm

<b>Overall width</b>	22 mm
<b>Contact distance</b>	11 mm
<b>Contacts</b>	2P + E
<b>Protection</b>	IP 65 according to EN 60529 requires a flat gasket
<b>For use with series</b>	86-MV-5-28, 86-MV-5-14, 86-MV-5-24, 86-MV-5-38, 86-MV-5-12, 86-MV-3, 86-MN-4, 86-MS-3V



Model-no.:	28-ST-01	86-ST-04-112	28-ST-04-127
<b>Voltage (AC/DC)</b>	0 - 250 V	24 V DC	220 V AC
<b>Status indicator</b>	no	yes	yes
<b>Protective circuit</b>	no	no	no
<b>Connecting cable</b>	without	without	without
<b>Wire cross section</b>	max. 1.5 mm <sup>2</sup>	max. 1.5 mm <sup>2</sup>	max. 1.5 mm <sup>2</sup>
<b>∅ Connecting cable</b>	6 - 8 mm	6 - 8 mm	6 - 8 mm

### Dimensions

#### Form B industrial norm

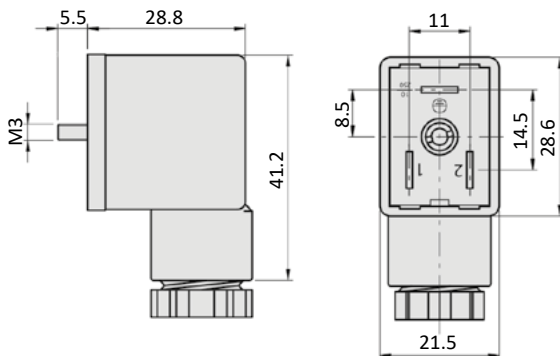

### Form B industrial norm

<b>Overall width</b>	22 mm
<b>Contact distance</b>	11 mm
<b>Contacts</b>	2P + E
<b>Protection</b>	IP 65 according to EN 60529 with connected plug socket
<b>Duty cycle</b>	100 %
<b>Temperature range*</b>	-20°C...+50°C
<b>Voltage tolerance</b>	± 10 %
<b>For use with series</b>	86-MV-5-28, 86-MV-5-14, 86-MV-5-24, 86-MV-5-38, 86-MV-5-12, 86-MV-3, 86-MN-4

\* The max. applicable operating temperature depends on the temperature specification of the used valve.



<b>Model-no.:</b>	86-SP-011-412	86-SP-011-427
<b>Voltage</b>	24 V DC	220 V AC
<b>Power consumption DC</b>	3 W	-
<b>Power consumption AC</b>	-	3.5 VA