

PCB Relays

Printed Circuit Board Relays
 Monostable
 OA 5652, OA 5661, OA 5662, OA 5692

Translation
 of the original instructions

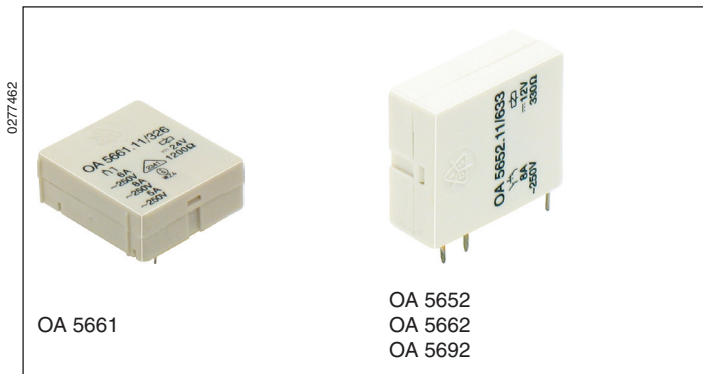

- According to DIN EN 61810-1, DIN EN 60664-1
- Different pin configurations and pin arrangements
- Clearance and creepage distances:
 Contact-coil ≥ 8 mm
- Compact size, small height (horizontal model)
- OA 5661 horizontal models
- OA 5652, OA 5662, OA 5692 vertical models
- Solder line proof

Applications

- Control technique
- Interface

Approvals and Markings



Technical Data

Relay type	OA 5652, OA 5661, OA 5662, OA 5692	
1.0 Relay coil		
1.1 Nominal voltage	DC V	DC 6; 12; 15; 20; 24; 48; 60 V (others on request)
1.2 Nominal consumption	W	0.48 W
1.11 Voltage range	U_N	0.7 ... 1.8 U_N
1.13 Holding power (at 0.5 x U_N)	W	0.12 W
2.0 Contacts		
2.1 Contact arrangement		1 changeover contact ¹⁾
2.2 Contact material		AgSnO ₂ + 0.2 μ m Au; AgNi + 0.2 μ m Au (gold contacts ⁵⁾ on request)
2.3 Rated insulation voltage	AC V	AC 250 V
Switching voltage min./max.	V	10 V / 400 V
2.4 Limiting continuous current I_{th}	A	8 A (see operating voltage limit curve)
Switching current min./max.	A	10 mA ⁴⁾ / 10 A ²⁾
2.5 Switching power min./max.	VA	4 VA / 2000 VA
Switching power min./max.	W	30 ... 250 W (see limit curve for arc-free operation)
2.6 Switching capacity to IEC/EN 60947-5-1		
AC 15		NC: AC 230 V / 1 A NO: AC 230 V / 3 A
DC 13	AC V/A	NC: DC 24 V / 1 A NO: DC 24 V / 1 A
to UL 508	DC V/A	B150
2.7 Electrical life		At 1 s On, 1 s Off (see contacts service life)
at AC 250 V, 8 A, $\cos\phi = 1$	switching cycles	$> 2 \times 10^5$ switching cycles AgNi 10 $> 3 \times 10^5$ switching cycles AgSnO ₂
2.8 Switching frequency max.	switching cycles/s	20 switching cycles/s
2.9 Response time / Release time	ms	Typically 5 ms / Typically 7 ms
2.10 Contact force	cN	> 25 cN / > 10 cN; > 10 cN ³⁾ / > 8 cN ³⁾
2.14 Contact gap	mm	> 0.3 mm ⁴⁾
3.0 Other		
3.1 Mechanical life	switching cycles	30×10^6 switching cycles
3.2 Temperature range	$^{\circ}$ C	- 40 ... + 80 $^{\circ}$ C
3.3 Degree of protection		Solder line proof RT II
3.5 Vibration resistance		≥ 4 g, to max. 100 Hz, IEC/EN 60068-2-6
3.6 Climate resistance		40 / 080 / 04 (climate category); A/B/D IEC/EN 60068-1

¹⁾ NO and NC on request

²⁾ Max. 4 s or 10 % ED

³⁾ At OA 5652

⁴⁾ Typical values

⁵⁾ For AC/DC 10 mW ... 12 W, at 2 ... 60 V / 2 ... 300 mA

Technical Data

3.8	Insulation acc. to IEC 60664-1, EN 50178		
	Rated insulation voltage	AC V	AC 250 V
	Pollution degree		3
	Overtoltage category		III
	Test voltage		
	Contact- Coil (1 min)	AC kV eff.	≥ AC 4 kV eff.
	Transient voltage		
	Contact- Coil (1.2 - 50 μs)	kV	≥ 6 kV
	Clearance and creepage distances	mm	≥ 8 mm
3.9	Weight	g	13 g
4.0 Packing			
4.1	In blister	pieces	20 pieces
4.2	In case package	piece	200 pieces
5.0 Solder method			
5.1	Solder method /-temperature /-duration	°C / s	Wave soldering / 260 °C / 5 s

Design versions

U _N (DCV)	Voltage range (DC V)	R _{Coil} Ω±10%	AgNi10-contacts + 0.2 μm Au				AgSnO ₂ -contacts + 0.2 μm Au			
			OA 5652	OA 5661	OA 5662	OA 5692	OA 5652	OA 5661	OA 5662	OA 5692
6	4.2 ... 10.8	80	635	285	270	411	665	323	328	432
12	8.4 ... 21.6	330	636	286	271	412	666	324	329	433
15	10.5 ... 27.0	475	637	291	272	413	667	321	330	434
20	14.0 ... 36.0	880	638	287	273	414	668	325	331	435
24	16.8 ... 43.2	1 200	639	288	274	415	669	326	332	436
48	33.6 ... 86.4	4 700	640	289	275	416	670	327	333	437
60	42.0 ... 108.0	7 250	641	293	276	417	671	322	334	438

Ordering Example

OA 56 . .11 / - /61*)

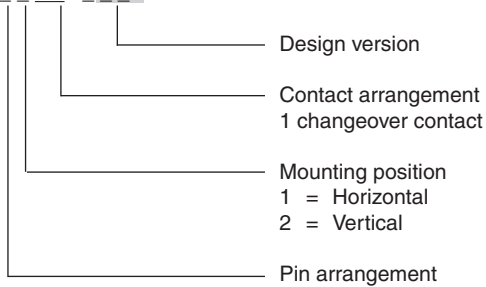

*) /61 cURus approval

Notes

For the use and processing of our PCB relays, please refer to the **application and processing instructions** at www.dold.com

Characteristics

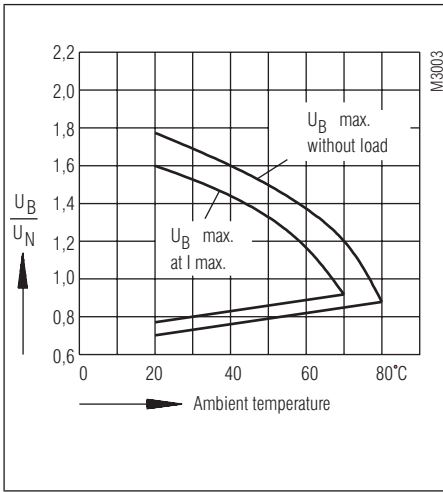

Operating voltage limit curve

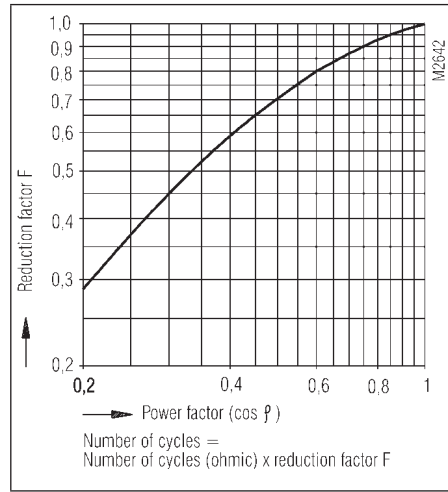

Reduction factor for inductive loads

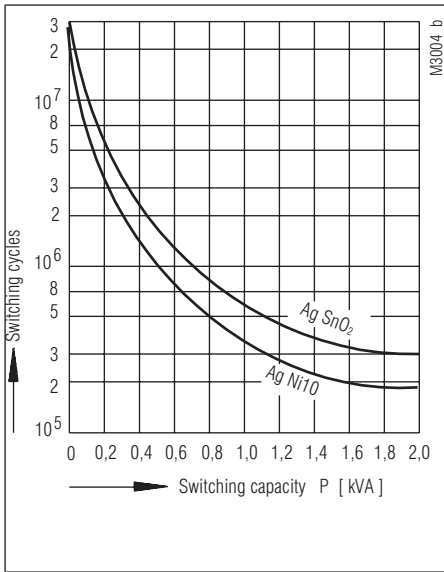

Contact service life (at t_u = 20°C)

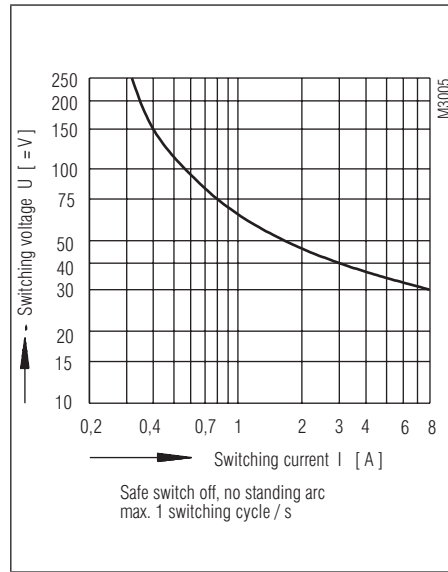

Arc limit curve (at t_u = 20°C)

Drilling plan (solder side)

OA 5652

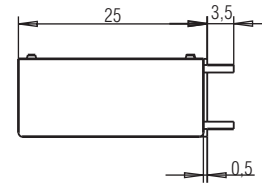
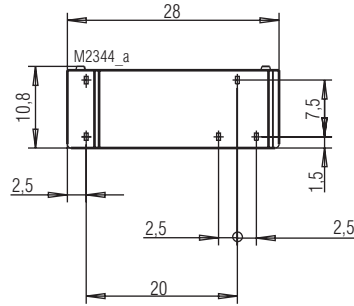
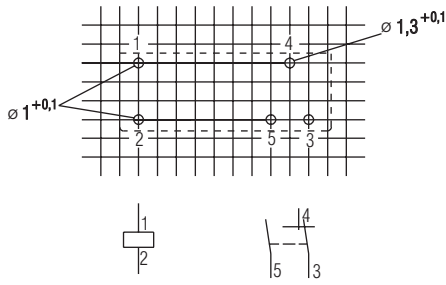

OA 5652.11

OA 5661

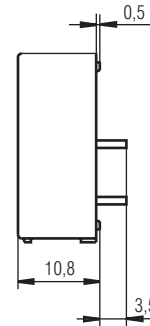
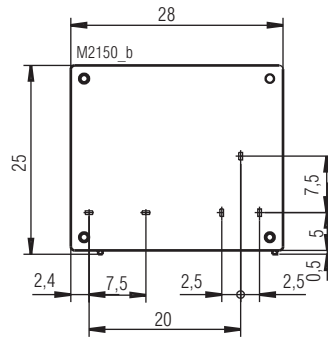
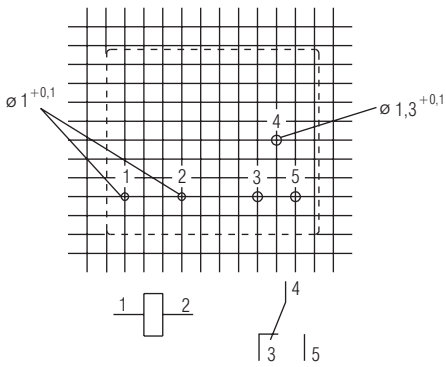

OA 5662

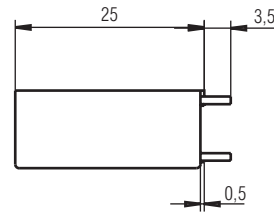
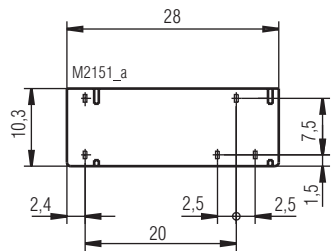
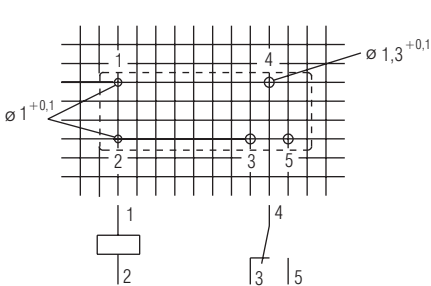

OA 5662.11

OA 5692

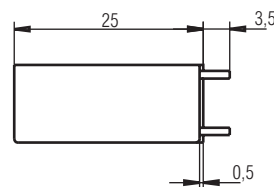
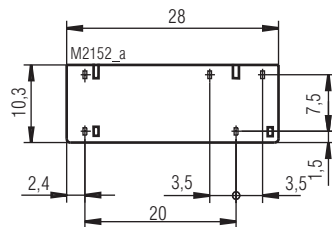
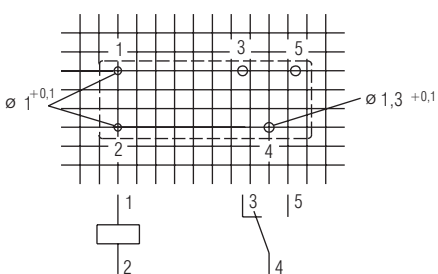

OA 5692.11

Connection for basic grid dimensions 2.5 mm as well as 2.54 mm according to IEC/EN 60097 and IEC 60326 average