

CHARACTERISTICS

- 3 PUMP MODELS:
 - 1 -12 PUMP ELEMENTS
 - 1 -24 PUMP ELEMENTS
 - 1 -35 PUMP ELEMENTS
- 12V AND 24V VERSIONS
- 12 TIMER SETTINGS
- 6 DIFFERENT PUMP ELEMENT SIZES
- PUMP –TO–POINT CONCEPT IS EASY TO ENGINEER
- EASY TO INSTALL
- 2 LITERS RESERVOIR

APPLICATIONS

- ANY TYPE OF DEVICE OR MACHINERY THAT REQUIRES GREASE LUBRICATION FROM 1 TO 35 LUBRICATION POINTS

THE COMPACT MULTI-OUTLET GREASE PUMP

The electrical action **PoliPUMP** is the **easy, fast and convenient** solution for lubrication of multi-point systems.

In just a few steps, you can install a centralised, automatic lubrication system, **up to a maximum of 35 lubrication points**.

No external metering valves, cycle sensors are required. Just plug and pipe it in and you are ready to go.

Compact and easy to use, it does not require any specific technical skills for assembly.



**SUPPLY UP TO 35 GREASE POINTS WITH ONE PUMP.
NO COMPLEX METERING VALVES OR SYSTEM DESIGN IS NECESSARY**

CAN BE USED STRAIGHT OUT OF THE BOX IN JUST A FEW QUICK STEPS:

- Choose from a range of 6 different Pump Elements for each lubrication point;
- Screw the Pump elements into the Outlet Manifold block;
- Quickly connect the pump elements to the points with flexible tubing – thanks to push-in fitting on the pump element;
- Power up the unit and select one of the 12 timer settings.

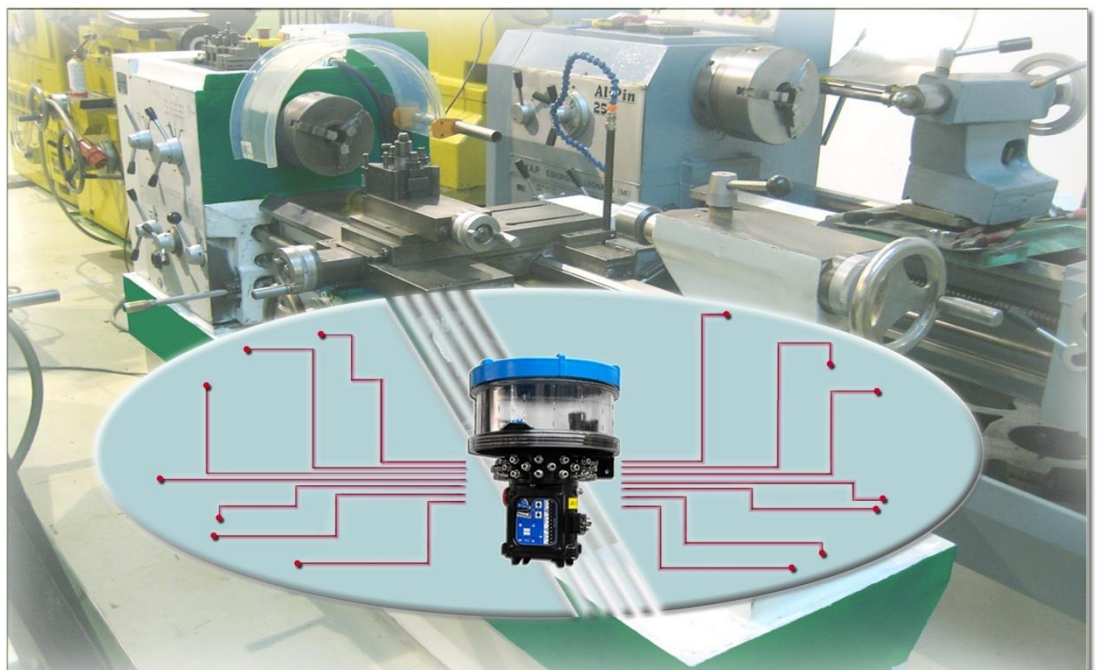

PURCHASE AND GET THE PUMP UP AND RUNNING IN JUST A FEW SIMPLE STEPS:

1. PICK NUMBER AND TYPE OF YOUR PUMPING ELEMENTS

Pumping elements are installed sequentially around the outlet manifold.

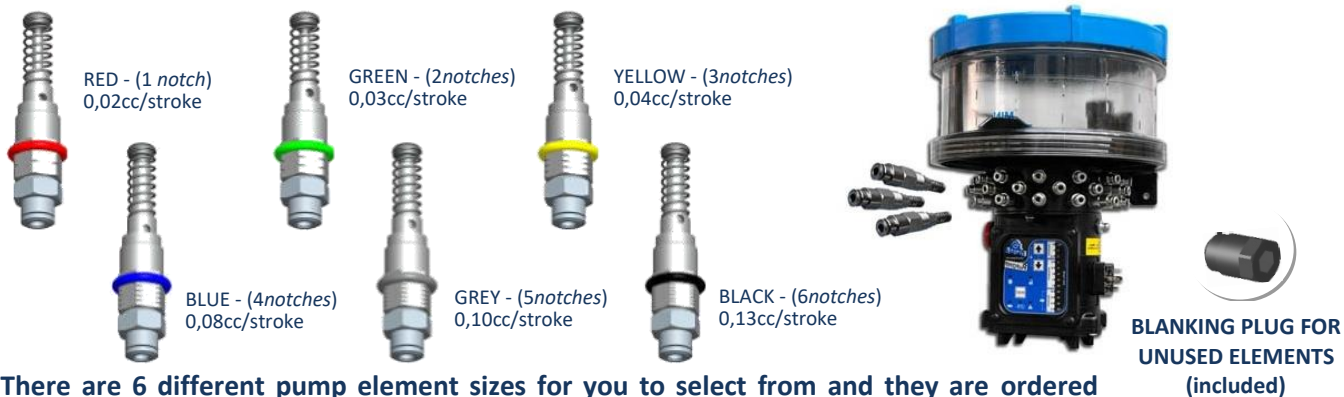

There are 6 different pump element sizes for you to select from and they are ordered separately from the pump according to how many lubrication points need to be serviced.

2. SELECT THE LUBRICATION CYCLE TIMER YOU WANT:

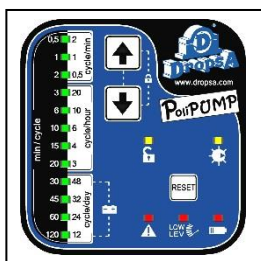

Once the pump has been powered on, simply use the up and down buttons to select the desired Lubrication Cycle.

There are 12 different cycle times that can be selected:

The cycle frequency available are:

- Cycles per minute: 0.5 – 1 – 2
- Cycles per hour: 3 – 4 – 6 – 10 – 20
- Cycles per day: 12 – 24 – 32 – 48

READY TO GO!



DIMENSIONS (NOT TO SCALE)

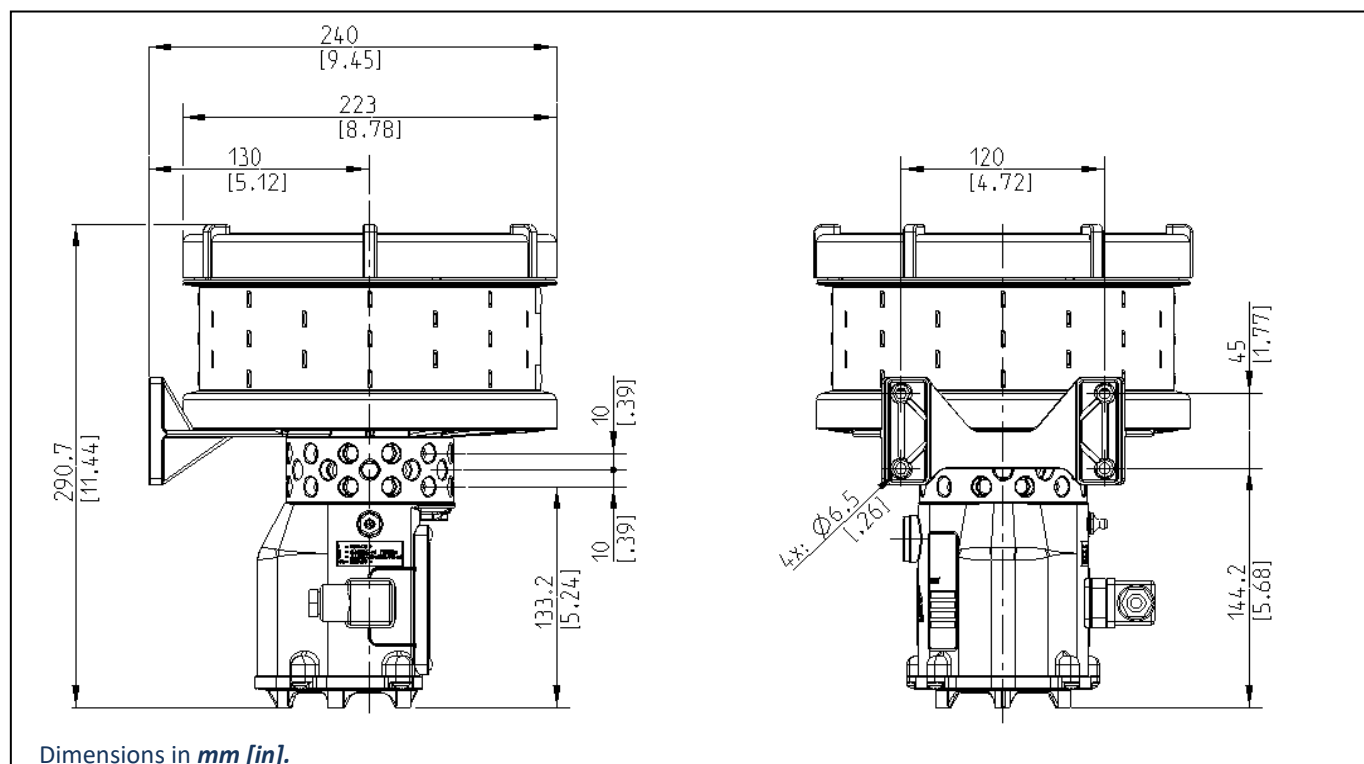

Dimensions in *mm [in]*.

GENERAL TECHNICAL CHARACTERISTICS

Pumping system	<i>Single acting pump elements with cam activation</i>	
Drive assembly	<i>DC motor with gearbox</i>	
Motor operating voltage	12V DC	24V DC
Electronic protection threshold for motor overload	0.6 A	
Nett weight	3 Kg (6.6 lb)	
Number of outlets / pumping max.	12 – 24 – 35	
Output connection (pumping outlet)	<i>Push-in Ø4</i>	
Nominal output per pump element	0,02cc/strokes – RED (1 notch) 0,03 cc/ strokes – GREEN (2 notches) 0,04 cc/ strokes – YELLOW (3 notches) 0,08 cc/ strokes – BLUE (4 notches) 0,10 cc/ strokes – GREY (5 notches) 0,13 cc/ strokes – BLACK (6 notches)	
Max pressure achievable at the outlet of the pumping	80 bar	
Reservoir Capacity (standard version)	<i>Standard 2 L (0.53 US gallons- 0,44 UK Gallons)</i>	
Grease capability	NLGI00 ÷ NLGI2	
Operating temperature	-10°C ÷ +60°C (14°F ÷ 140°F)	
Storage temperature	-20°C ÷ +80°C (-4°F ÷ 176°F)	
Humidity	90%	
Noise	< 70 db (A)	
Minimum level signalling/counting revolution	<i>With Hall effect sensor</i>	

CONTROL PANEL CHARACTERISTICS

Working voltages	12VDC – 24VDC
Operating temperature	-10°C ÷ +60°C (14°F ÷ 140°F)
Storage temperature	-20°C ÷ +80°C (-4°F ÷ 176°F)
Hardware characteristics	<ul style="list-style-type: none"> • Motor Overload protection • Input power protection • Remote Alarm signal • Completed Cycle control sensor
Relay alarm contact	NC (open in alarm) – I max 5A - Vmax 250V – Pmax 60W



POLIPUMP DESIGN WORKSHEET

1.SELECT THE PUMP – Pick a model:

Standard PoliPUMP

(includes external alarm relay connection)

12VDC	FROM1TO12 PUMPINGS	0888270	<input type="radio"/>	
	FROM1TO24 PUMPINGS	0888271	<input type="radio"/>	
	FROM1TO35 PUMPINGS	0888272	<input type="radio"/>	
24VDC	FROM1TO12 PUMPINGS	0888273	<input type="radio"/>	
	FROM1TO24 PUMPINGS	0888274	<input type="radio"/>	
	FROM1 TO35 PUMPINGS	0888275	<input type="radio"/>	

2.HOW MANY PUMP ELEMENTS DO YOU NEED?

PUMP ELEMENTS				Q.TY
,02cc/ stroke	RED - (1 notch)	0888451	<input type="radio"/>	
0,03cc/ stroke	GREEN- (2notchs)	0888452	<input type="radio"/>	
0,04cc/ stroke	YELLOW- (3 notchs)	0888453	<input type="radio"/>	
0,08cc/ stroke	BLUE- (4notchs)	0888454	<input type="radio"/>	
0,10cc/ stroke	GREY- (5notchs)	0888455	<input type="radio"/>	
0,13cc/ stroke	BLACK- (6 notchs)	0888456	<input type="radio"/>	
,02cc/ stroke	RED - (1 notch)	0888172	<input type="radio"/>	
0,03cc/ stroke	GREEN- (2notchs)	0888173	<input type="radio"/>	
0,04cc/ stroke	YELLOW- (3 notchs)	0888174	<input type="radio"/>	
0,08cc/ stroke	BLUE- (4notchs)	0888175	<input type="radio"/>	
0,10cc/ stroke	GREY- (5notchs)	0888176	<input type="radio"/>	
0,13cc/ stroke	BLACK- (6 notchs)	0888177	<input type="radio"/>	
SPARE BLANKING PLUG		0888257	<input type="radio"/>	



3. TUBES AND FITTINGS?

TUBES Ø4						Q.TY
Ø4x2 Nylon tubeNylon Tube - Clear				5717218	<input type="radio"/>	
Ø4x3 Nylon Tube (low pressure)				5717300	<input type="radio"/>	
Ø4x2 Nylon Tube - Black				5717258	<input type="radio"/>	
Ø4x2 Nylon Tube - Black grease filled NLGI 00				5717259	<input type="radio"/>	
FITTINGS Ø4						
PUSH-IN	THREAD	MAX PRESSURE (bar)				
Straight	1/8 BSP	65	3084577	<input type="radio"/>		
	M6X1	65	3084579	<input type="radio"/>		
	M6X0,75	65	3084631	<input type="radio"/>		
	5/16-24 UMF	65	3084682	<input type="radio"/>		
	1/8" NPT	20	3084586	<input type="radio"/>		
90° swivel	M6X1	65	3084613	<input type="radio"/>		
	5/16-24 UMF	65	3084611	<input type="radio"/>		
	1/8NPT	65	3084620	<input type="radio"/>		
	1/8 BSP	65	3084638	<input type="radio"/>		
	M8X1	150	3084731	<input type="radio"/>		
	1/8 BSP	150	3084696	<input type="radio"/>		
Compression	1/8" BSP	150	0092069	<input type="radio"/>		

4. FILL THE PUMP

Loading kit for 400 cc cartridge	0888038	<input type="radio"/>	
Loading kit for 400 cc cartridge with valves	3133723	<input type="radio"/>	
400 cc grease cartridge (NLGI 2)	1524952	<input type="radio"/>	
Fitting for 90° loading M22x1.5	3077222	<input type="radio"/>	

ACCESSORIES

Black ties wraps 100 x 2,5 mm (1 unit)		UE-CACA011	<input type="radio"/>	
Spiral fits- black 10 m per coil ø 10-50 mm		UE-CACA030	<input type="radio"/>	
Tag kit		3133901	<input type="radio"/>	