

Technical features

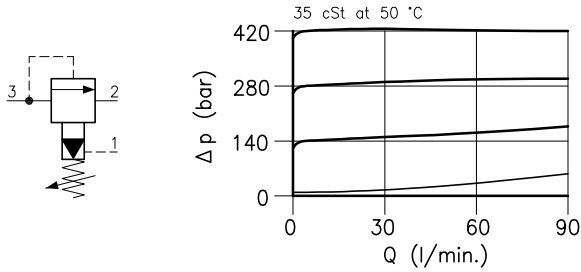

Cavity	(For dimensions see catalogue 17.000)	S 30/3
Max. flow	(l/min.)	70
Max. inlet pressure	(bar)	420
Max. pressure on line 2	(bar)	420
Max. drain on line 1	(l/min.)	1.2
Fluid viscosity range	(cSt)	2.8 - 380
Fluid temperature range	(°C)	-20 +80
Mass	(kg)	0.200
Standard setting obtained with 10 l/min.		
Hydraulic fluid; mineral oil HM and HV ISO 6074		
Recommended filtration; 19/15 ISO 4466 (25 μ absolutes)		
Standard seals in Polyurethane and Buna N		

Dimensions

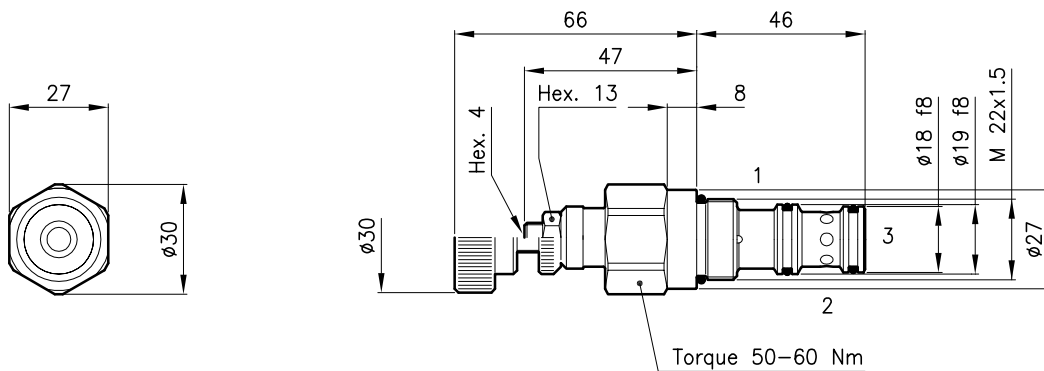

Ordering informations

LPY 30/D-N

LPY 30 = Valve type

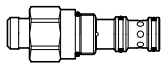

Standard springs

Type	Setting range	Factory set
D	= 10 - 210 bar	140 bar
Q	= 105 - 420 bar	315 bar

Adjustment type

- N** = Standard adjustment
- V** = Handknob adjustment

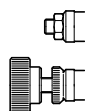

Codes:

LPY 30/D-N	31 011 130
LPY 30/Q-N	31 011 131
LPY 30/D-V	31 011 132
LPY 30/Q-V	31 011 133
External seals kit	90 620 104

LPY 30 valves can be assembled on standard bodies 30-C3 series; for dimensions see catalogue 16.010