

Technical features

05

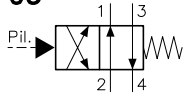

11

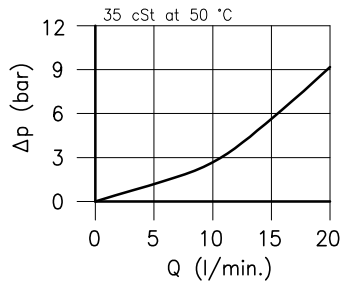
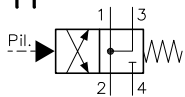

Cavity	(For dimensions see catalogue 17.000)	S 20/4
Nominal flow	(l/min.)	15
Max. pressure	(bar)	350
Pilot pressure	(bar)	3 - 5
Pilot volume	(cm ³)	0.12
Fluid viscosity range	(cSt)	2.8 - 380
Fluid temperature range	(°C)	-20 +80
Mass	(kg)	0.100
Hydraulic fluid; mineral oil HM and HV ISO 6074		
Recommended filtration; 19/15 ISO 4466 (25 μ absolutes)		
Standard seals in Polyurethane and Buna N		

Dimensions

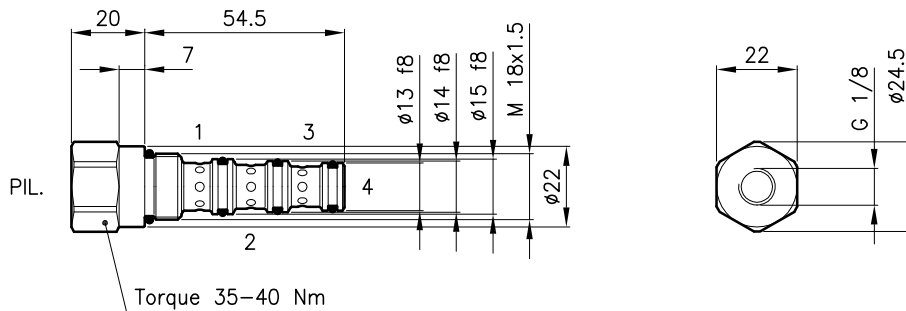

Ordering informations

VDT 20/4211

VDT 20 = Valve type

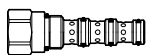

Circuits

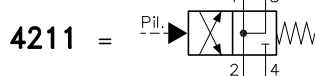
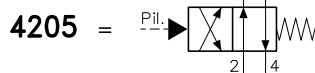

Codes:

VDT 20/4205	22 011 134
VDT 20/4211	22 011 135
External seals kit	90 620 102

VDT 20 valves can be assembled on standard bodies 20-C4 series; for dimensions see catalogue 16.011