

Product Information

**Flow switch
HR2VO1**



- Viscosity stabilised
- Individually calibrated display
- Compact design

Characteristics

Mechanical flow switch for fluid media, with spring-supported piston and magnetic triggering of a reed switch. Robust construction in brass or stainless steel.

Technical data

Switch	without	
Nominal width	DN 32 / 40 / 50	
Process connection	female thread G 1 1/4..G 2 (further process connections available on request)	
Display range	10..150 l/min	for details see table "Ranges"
Pressure loss	~ 4..7 bar at Q _{max}	
Q _{max.}	up to 160 l/min	
Tolerance	±10 % of full scale value at constant viscosity	
Viscosity-stability	mean deviation ±7 %, max. 18 % (30-330 mm ² /s) of full scale value	
Pressure resistance	PS 200 bar	
Media temperature	-20..+120 °C	
Ambient temperature	-20..+70 °C	
Media	oil	
Electrical connection	none	
Materials medium-contact	Brass construction: CW614N nickelled, CW614N, 1.4305, 1.4310, hard ferrite	Stainless steel construction: 1.4571, 1.4310, hard ferrite
Non-medium-contact materials	CW614N nickelled, PC, acrylic	
Weight	see table "Dimensions and weights"	
Installation location	Standard: horizontal inwards flow from the left; other installation positions are possible; the installation position affects the switching point and range.	

Ranges

Details in the table correspond to horizontal inwards flow with increasing flow rate.

Display range l/min oil 30-330 mm ² /s	Q _{max.} Recommended l/min	Pressure loss bar at Q _{max.} oil
10 - 60	100	4
20 - 100	120	5
40 - 120	140	5
50 - 150	160	7

Special ranges are available.

Reference Data:

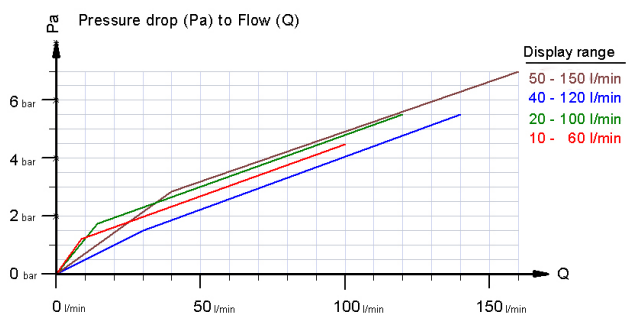

Display spaces of the flow switch HR2VK1

Dimensions and weights

DN	G	Types	L	ØD	SW	Ød	X	Weight kg
32	G 1 1/4	HR2VO1-032GM	130	65	60	51	23	2.5
40	G 1 1/2	HR2VO1-040GM	170	65	60	56	24	3.1
50	G 2	HR2VO1-050GM	185	80	75	70	26	5.2

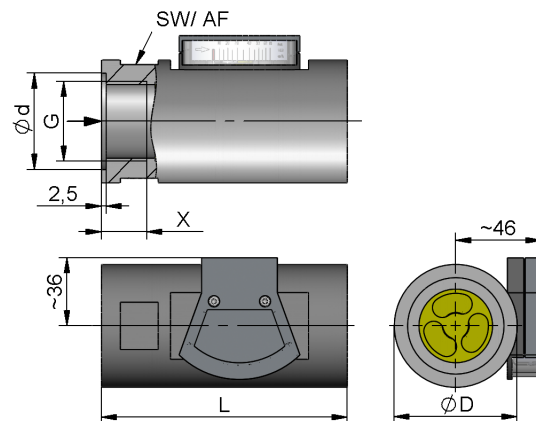

Product Information

Handling and operation

Note

- Include straight calming section of 5 x DN in inlet and outlet
- If the media are dirty, install a filter (use magnetic filter for ferritic components).
- Under unfavorable pressure conditions, e.g. with a free outlet, there is a risk of cavitation.

Ordering code

HR2VO1 - 1. 2. 3. 4.

1. Nominal width	
032	DN 32 - G 1 ¹ / ₄
040	DN 40 - G 1 ¹ / ₂
050	DN 50 - G 2
2. Process connection	
G	female thread
3. Connection material	
M	brass
K	stainless steel
4. Display range H₂O for horizontal inwards flow	
060	10 - 60 l/min
100	15 - 100 l/min
120	40 - 120 l/min
150	50 - 150 l/min

Options

- Special values

Ordering information

- Specify direction of flow, medium, and display range.