

JUMO GmbH & Co. KG
 Delivery address: Mackenrodtstraße 14
 36039 Fulda, Germany
 Postal address: 36035 Fulda, Germany
 Phone: +49 661 6003-0
 Fax: +49 661 6003-607
 Email: mail@jumo.net
 Internet: www.jumo.net

JUMO Instrument Co. Ltd.
 JUMO House
 Temple Bank, Riverway
 Harlow, Essex, CM20 2DY, UK
 Phone: +44 1279 63 55 33
 Fax: +44 1279 62 50 29
 Email: sales@jumo.co.uk
 Internet: www.jumo.co.uk

JUMO Process Control, Inc.
 6724 Joy Road
 East Syracuse, NY 13057, USA
 Phone: +1 315 437 5866
 Fax: +1 315 437 5860
 Email: info.us@jumo.net
 Internet: www.jumousa.com



JUMO diraVIEW 104/108/116/132

Digital indicator

Brief description

The digital indicator series comprises five freely configurable, universally usable devices in various DIN formats to display temperature, pressure, and other process variables.

The devices are characterized by a simple, clearly structured operation supported with texts. Process values and parameters are represented by two 18-segment LCD displays. The types 701512, 701513, and 701514 are additionally equipped with a pixel matrix LCD display for displaying text. In addition, all devices have individual display elements for the switch positions of the outputs as well as for the timer. The devices are operated using a membrane keyboard with four buttons and can be used under harsh environmental influences thanks to the high IP65 protection type.

The basic type includes a min/max value display function, a hold function, a taring function, limit value monitoring functions, digital control signals, extensive timer functions, and a service counter. A math and logic function is also available as an option. Furthermore, the user has the option to create his/her own application using structured text (ST code).

The devices can be conveniently configured using a PC with the help of the setup program (incl. ST editor). No separate voltage supply is required when configuring via the USB interface (USB-powered).



diraVIEW 108 (Q) / type 701513

Block diagram

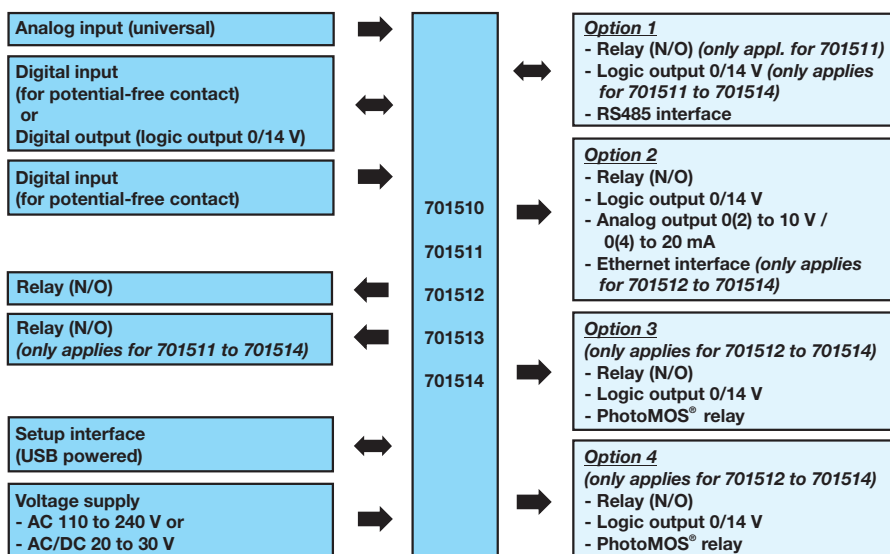

Special features

- Min/max value memory and display
- Hold function
- Taring function for weighing applications
- Customer-specific linearization (40 value pairs or polynomial)
- Timer function
- Four limit value monitoring functions
- Individual user level
- Separate application using structured text (ST code; option)
- Math and logic function (option)
- Fast wiring through Push-In technology
- Analog output (option)
- RS485 or Ethernet interface (option)
- Additional analog and digital inputs via interface

Approvals and approval marks (see technical data)





Device types



diraVIEW 132 / type 701510



diraVIEW 116 / type 701511



diraVIEW 108 (H) / type 701512



diraVIEW 108 (Q) / type 701513

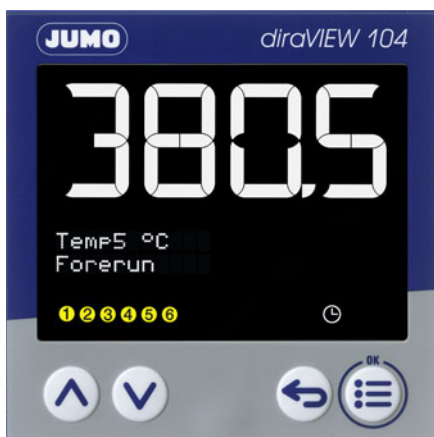

diraVIEW 104 / type 701514

Description

Inputs and outputs

Each device type has a universal analog input (for RTD temperature probe, thermocouple, current, voltage, resistance transmitter, resistance/potentiometer), a digital input and a switchable digital input/output. With the exception of type 701510, where the basic type has one relay output (N/O contact), all remaining types are equipped with two relay outputs (N/O contacts). The digital inputs are provided to connect a potential-free contact. The digital output provides a logic signal 0/14 V.

Additional relay outputs (N/O contacts), the logic outputs (0/14 V), PhotoMOS[®] relay outputs¹ and an analog output (0(2) to 10 V / 0(4) to 20 mA) are available as options.

Certain inputs and outputs cannot be used simultaneously (see notes in the connection diagram).

Signal allocation via selectors

The input signals of the analog input and the digital inputs are available for further use in the device in so-called selectors (analog selector, digital selector). The trigger signals for the analog output and the digital outputs are also assigned via selectors, which allows for flexible signal/function assignment.

Interfaces

The device is equipped with a USB device interface (micro-B socket on the rear of the device) that is provided for the connection to a PC and is only used for the setup program. Thereby the device is powered via the USB interface. As a result, no mains supply is required during the configuration.

A RS485 interface is also available as an option which is provided for communication with a Modbus master (Modbus-RTU operating mode). The master can transmit up to two analog values and two binary values to the device that are used there as external input signals. Two analog flags and two digital flags (binary) are also available.

An Ethernet interface is also available as an option, which supports the Modbus-TCP and Modbus-RTU/ASCII via TCP operating modes. This allows the same parameters and process values to be transferred as via the RS485 interface.

¹ PhotoMOS is a registered trademark of Panasonic Corporation.

Voltage supply

The device is available in two voltage supply variants: AC 110 to 240 V or AC/DC 20 to 30 V, each 48 to 63 Hz.

Electrical connection

The electrical connection saves time by using practical spring-cage terminals (Push-In technology).

Min/max function

The minimum and maximum measured values are stored and continuously updated when the min/max function is activated. Both values can be displayed separately or alternately with the current measured value.

The values can be reset to the current measured value by a binary signal.

Hold function

The hold function is activated by a binary signal. As long as the signal is active, the final measured value is "frozen" before the activation and displayed.

Taring function

The display value is set to zero with the taring function, controlled by a binary signal (weighing function). The function can be reset with an additional binary signal.

Limit value monitoring functions

The device is equipped with four limit value monitoring functions, each with eight configurable alarm functions. Any analog signal from a selector is selected as the value to be monitored. An absolute value or a value that depends on an additional analog signal serves as the limit value. Special functions such as switch-on/switch-off delay, pulse function, alarm suppression in the switch-on phase or in case of a parameter change, alarm latch and lock with acknowledgment are available. With the limit value monitoring function, extensive alarm and limit value functions can be implemented.

Digital controller signals

Up to four digital control signals can be configured using this function. In this process, the control signal is formed either by an AND/OR/XOR link of up to three selectable binary signals.

Or a single binary signal serves as an input signal and is output as a pulse-shaped signal, as a delayed signal, as a so-called wiper signal, or as an edge-triggered signal. In the latter case the rising or falling edge of the binary signal is detected, and the output signal is activated for the duration of the sampling interval.

JUMO GmbH & Co. KG

Delivery address: Mackenrodtstraße 14
36039 Fulda, Germany
Postal address: 36035 Fulda, Germany
Phone: +49 661 6003-0
Fax: +49 661 6003-607
Email: mail@jumo.net
Internet: www.jumo.net

JUMO Instrument Co. Ltd.

JUMO House
Temple Bank, Riverway
Harlow, Essex, CM20 2DY, UK
Phone: +44 1279 63 55 33
Fax: +44 1279 62 50 29
Email: sales@jumo.co.uk
Internet: www.jumo.co.uk

JUMO Process Control, Inc.

6724 Joy Road
East Syracuse, NY 13057, USA
Phone: +1 315 437 5866
Fax: +1 315 437 5860
Email: info.us@jumo.net
Internet: www.jumousa.com



The output signal can be inverted in all specified cases.

Timer

After the timer is started, a signal is output for the duration of the timer running time; this signal is invertible. It is also possible to start the timer after the lead time has elapsed or after reaching a tolerance limit. A timer end signal can be output after the timer has elapsed (limit by time or acknowledgement).

The timer can be used to implement various, time-dependent functions.

Service counter

The device is equipped with a counter function that can be used as a service counter. To this end, either the switching frequency of a binary signal is counted or its duty cycle is determined. When the set limit value is reached, a binary signal is activated that needs to be acknowledged.

In addition, an operating hours counter is available that determines the device's operation time.

Math and logic function

The optional math and logic function (extra code) can be used to link analog or binary values. Up to four freely configurable maths or logic formulae can be created using the setup program. The results are available in the analog or digital selector for further use.

Individual user level

The individually configurable user level contains up to 16 editable configuration parameters. The parameters are selected in the setup program.

Setup program

The setup program provides the user with an easy and comfortable way to configure the device using a PC. You can use it to create and edit data records, transfer them to the device, and extract them from it. The data can be stored and printed. In addition, the user can easily create and print out a connection diagram that shows the current terminal assignment of the device.

Startup: the startup function is for recording process variables during startup (max. 24 hours). The recorded diagrams are available on the PC and can, for example, be used for system documentation.

Online data: The device's current process variables are shown in a separate window.

Customer-specific linearization

Sensor signals with special characteristic line characteristics can also be used through customer-specific linearization. Programming is carried out in the setup program on the basis of a value table with up to 40 value pairs or through a formula (4th order polynomial).

Structured text

The user has the option to create his/her own application using the "Structured text" option (extra code).

The application with the ST editor, which is part of the setup program, is created in the PLC programming language "Structured text". The finished application is transmitted to the device and continuously processed there. There are online-debugger functions available in the ST editor for testing and troubleshooting.

Up to 10 stored text messages can be displayed via the ST code depending on the application.

JUMO GmbH & Co. KG
 Delivery address: Mackenrodtstraße 14
 36039 Fulda, Germany
 Postal address: 36035 Fulda, Germany
 Phone: +49 661 6003-0
 Fax: +49 661 6003-607
 Email: mail@jumo.net
 Internet: www.jumo.net

JUMO Instrument Co. Ltd.
 JUMO House
 Temple Bank, Riverway
 Harlow, Essex, CM20 2DY, UK
 Phone: +44 1279 63 55 33
 Fax: +44 1279 62 50 29
 Email: sales@jumo.co.uk
 Internet: www.jumo.co.uk

JUMO Process Control, Inc.
 6724 Joy Road
 East Syracuse, NY 13057, USA
 Phone: +1 315 437 5866
 Fax: +1 315 437 5860
 Email: info.us@jumo.net
 Internet: www.jumousa.com



Technical data

Analog input

Thermocouples

Designation	Type	Standard	ITS	Measuring range	Accuracy ^a
Fe-CuNi	"L"	DIN 43710 (1985)	IPTS-68	-200 to +900 °C	≤ 0.25 %
Fe-CuNi	"J"	DIN EN 60584-1:2014 IEC 60584-1:2013	ITS-90	-210 to +1200 °C	≤ 0.25 % from -100 °C
Cu-CuNi	"U"	DIN 43710 (1985)	IPTS-68	-200 to +600 °C	≤ 0.25 % from -100 °C
Cu-CuNi	"T"	DIN EN 60584-1:2014 IEC 60584-1:2013	ITS-90	-270 to +400 °C	≤ 0.25 % from -150 °C
NiCr-Ni	"K"	DIN EN 60584-1:2014 IEC 60584-1:2013	ITS-90	-270 to +1300 °C	≤ 0.25 % from -80 °C
NiCr-CuNi	"E"	DIN EN 60584-1:2014 IEC 60584-1:2013	ITS-90	-270 to +1000 °C	≤ 0.25 % from -80 °C
NiCrSi-NiSi	"N"	DIN EN 60584-1:2014 IEC 60584-1:2013	ITS-90	-270 to +1300 °C	≤ 0.25 % from -80 °C
Pt10Rh-Pt	"S"	DIN EN 60584-1:2014 IEC 60584-1:2013	ITS-90	-50 to +1768 °C	≤ 0.4 % from 20 °C
Pt13Rh-Pt	"R"	DIN EN 60584-1:2014 IEC 60584-1:2013	ITS-90	-50 to +1768 °C	≤ 0.25 % from 50 °C
Pt30Rh-Pt6Rh	"B"	DIN EN 60584-1:2014 IEC 60584-1:2013	ITS-90	-50 to +1820 °C	≤ 0.25 % from 400 °C
W5Re-W26Re	"C"	DIN EN 60584-1:2014 IEC 60584-1:2013	ITS-90	0 to 2315 °C	≤ 0.25 % from 500 °C
W3Re-W25Re	"D"	ASTM E1751M-15	ITS-90	0 to 2315 °C	≤ 0.25 % from 500 °C
W5Re-W20Re	"A1"	GOST R 8.585-2001	ITS-90	0 to 2500 °C	≤ 0.25 % from 500 °C
Chromel®-Copel	"L"	GOST R 8.585-2001	ITS-90	-200 to +800 °C	≤ 0.25 % from -80 °C
Chromel®-Alumel®	"K"	GOST R 8.585-2001	ITS-90	-270 to +1300 °C	≤ 0.25 % from -80 °C

^a The accuracy value refers to the measuring range.

Ambient temperature influence	≤ 100 ppm/K
Cold junction	Internal or external (constant)
Reference point temperature (external)	0 to 100 °C (adjustable)
Sampling rate	150 ms
Input filter	Digital filter, 2nd order; filter constant can be set from 0 to 100.0 s

RTD temperature probe

Designation	Standard	ITS	Connection type	Measuring range	Accuracy ^a	Measuring current
Pt100	DIN EN 60751:2009 IEC 60751:2008	ITS-90	Two-wire	-200 to +850 °C	≤ 0.2 %	500 µA
			Three-wire	-200 to +850 °C	≤ 0.1 %	500 µA
Pt1000	DIN EN 60751:2009 IEC 60751:2008	ITS-90	Two/three-wire	-200 to +850 °C	≤ 0.1 %	50 µA
Pt100	GOST 6651-2009 A.2	ITS-90	Two-wire	-200 to +850 °C	≤ 0.2 %	500 µA
			Three-wire	-200 to +850 °C	≤ 0.1 %	500 µA
KTY			Two-wire	-53 to +153 °C	≤ 2.0 %	50 µA

^a The accuracy value refers to the measuring range.

JUMO GmbH & Co. KG
 Delivery address: Mackenrodtstraße 14
 36039 Fulda, Germany
 Postal address: 36035 Fulda, Germany
 Phone: +49 661 6003-0
 Fax: +49 661 6003-607
 Email: mail@jumo.net
 Internet: www.jumo.net

JUMO Instrument Co. Ltd.
 JUMO House
 Temple Bank, Riverway
 Harlow, Essex, CM20 2DY, UK
 Phone: +44 1279 63 55 33
 Fax: +44 1279 62 50 29
 Email: sales@jumo.co.uk
 Internet: www.jumo.co.uk

JUMO Process Control, Inc.
 6724 Joy Road
 East Syracuse, NY 13057, USA
 Phone: +1 315 437 5866
 Fax: +1 315 437 5860
 Email: info.us@jumo.net
 Internet: www.jumousa.com



Ambient temperature influence	≤ 50 ppm/K
Sensor line resistance	Max. 30 Ω per line
Sampling rate	150 ms
Input filter	Digital filter, 2nd order; filter constant can be set from 0 to 100.0 s

Resistance transmitter and resistor/potentiometer

Designation	Measuring range	Accuracy ^a	Measuring current
Resistance transmitter	0 to 4000 Ω	≤ 0.1 %	50 μA
Resistance/potentiometer	0 to 400 Ω	≤ 0.1 %	500 μA
	0 to 4000 Ω	≤ 0.1 %	50 μA

^a The accuracy value refers to the maximum measuring range. Small measuring spans lead to reduced linearization accuracy.

Ambient temperature influence	≤ 100 ppm/K
Connection type	
Resistance transmitter	Three-wire circuit
Resistance/potentiometer	Two-wire/three-wire circuit
Sensor line resistance	Max. 30 Ω per line
Sampling rate	150 ms
Input filter	Digital filter, 2nd order; filter constant can be set from 0 to 100.0 s

Voltage, current (standard signals)

Designation	Measuring range	Accuracy ^a	Input resistance or burden voltage
Voltage	0 to 10 V	≤ 0.1 %	> 500 kΩ
	2 to 10 V	≤ 0.1 %	> 500 kΩ
Current	4 to 20 mA	≤ 0.1 %	< 2.5 V
	0 to 20 mA	≤ 0.1 %	< 2.5 V

^a The accuracy value refers to the maximum measuring range. Small measuring spans lead to reduced linearization accuracy.

Ambient temperature influence	≤ 100 ppm/K
Deviation below/above the measuring range	According to NAMUR recommendation NE 43 (only current input 4 to 20 mA)
Sampling rate	150 ms
Input filter	Digital filter, 2nd order; filter constant can be set from 0 to 100.0 s

Measuring circuit monitoring

The device behavior in the event of a fault is configurable.

Measuring probe	Measuring range underflow	Measuring range overflow	Short-circuit (probe/line)	Break (probe/line)	Polarity
RTD temperature probe	++	++	++	++	---
Resistance/potentiometer	---	++	---	++	---
Resistance transmitter	---	++	(+) ^a	(+) ^b	---
Thermocouple	++	++	---	++	(+) ^c
Current 0 to 20 mA	---	++	---	---	---
Current 4 to 20 mA	++	++	++	++	++
Voltage 0 to 10 V	---	++	---	---	++
Voltage 2 to 10 V	++	++	++	++	++
++ = is detected		--- = is not detected		(+) = is detected in certain conditions	

^a Is not detected in all combinations

^b Break in measuring current path is not detected

JUMO GmbH & Co. KG
 Delivery address: Mackenrodtstraße 14
 36039 Fulda, Germany
 Postal address: 36035 Fulda, Germany
 Phone: +49 661 6003-0
 Fax: +49 661 6003-607
 Email: mail@jumo.net
 Internet: www.jumo.net

JUMO Instrument Co. Ltd.
 JUMO House
 Temple Bank, Riverway
 Harlow, Essex, CM20 2DY, UK
 Phone: +44 1279 63 55 33
 Fax: +44 1279 62 50 29
 Email: sales@jumo.co.uk
 Internet: www.jumo.co.uk

JUMO Process Control, Inc.
 6724 Joy Road
 East Syracuse, NY 13057, USA
 Phone: +1 315 437 5866
 Fax: +1 315 437 5860
 Email: info.us@jumo.net
 Internet: www.jumousa.com



^c Dependent on the set characteristic line

Digital inputs

Input for potential-free contact	
Function	Contact closed: input is active ($R_{ON} < 1 \text{ k}\Omega$) Contact open: input is inactive ($R_{OFF} > 50 \text{ k}\Omega$)
Sampling rate	150 ms

Analog output

Voltage	
Output signal	DC 0(2) to 10 V
Load resistance	> 500 Ω
Current	
Output signal	DC 0(4) to 20 mA
Load resistance	< 450 Ω
Accuracy	$\leq 0.5 \%$
Ambient temperature influence	$\leq 150 \text{ ppm/K}$

Digital outputs

Relay (N/O contact)	
Switching capacity	Max. 3 A at AC 230 V or DC 30 V, resistive load
Contact life	150,000 operations at rated load 350,000 operations at 1 A
Relay (N/O contact) with longer contact life	
Switching capacity	Max. 3 A at AC 230 V, resistive load
Contact life	300,000 operations at rated load 1,500,000 operations at 1 A
Logic output	
Output signal	DC 0/14 V $\pm 15 \%$
Current	Max. 20 mA per output (at nominal voltage 14 V)
PhotoMOS [®] relay ^a	
Switching capacity	Max. 200 mA at AC 30 V or DC 45 V; not short-circuit proof

^a PhotoMOS is a registered trademark of Panasonic Corporation.

Interfaces

USB device	
Connector type	Micro-B (socket)
Standard	Low-Speed, Full-Speed
Max. cable length	5 m
RS485	
Baud rate	9600, 19200, 38400, 115200
Data format	8/1n, 8/1e, 8/1o, 8/2n
Protocol	Modbus-RTU as slave
Ethernet	
Connector type	RJ45 (socket)
Transfer rate	10 Mbit/s, 100 Mbit/s
Protocol	TCP/IP, DHCP; Modbus-TCP, Modbus-RTU/ASCII via TCP, as slave

JUMO GmbH & Co. KG
 Delivery address: Mackenrodtstraße 14
 36039 Fulda, Germany
 Postal address: 36035 Fulda, Germany
 Phone: +49 661 6003-0
 Fax: +49 661 6003-607
 Email: mail@jumo.net
 Internet: www.jumo.net

JUMO Instrument Co. Ltd.
 JUMO House
 Temple Bank, Riverway
 Harlow, Essex, CM20 2DY, UK
 Phone: +44 1279 63 55 33
 Fax: +44 1279 62 50 29
 Email: sales@jumo.co.uk
 Internet: www.jumo.co.uk

JUMO Process Control, Inc.
 6724 Joy Road
 East Syracuse, NY 13057, USA
 Phone: +1 315 437 5866
 Fax: +1 315 437 5860
 Email: info.us@jumo.net
 Internet: www.jumousa.com



Display

18-segment LCD displays		
Digit height	Upper display:	Lower display:
Type 701510 (format 132)	7.2 mm	3.8 mm
Type 701511 (format 116)	12.3 mm	5.9 mm
Type 701512 (format 108H)	11.5 mm	8.5 mm
Type 701513 (format 108Q)	16.5 mm	9 mm
Type 701514 (format 104)	24.8 mm	12 mm
Color	Upper display: white; lower display: green	
Places, including decimal places	Upper display: 4; lower display: 4 (5 for type 701510, 8 for type 701511)	
Decimal places	0, 1, 2, 3 or automatic (configurable)	

Pixel matrix LCD display (only for types 701512, 701513, and 701514)	
Pixel fields	
Type 701512 (format 108H)	2 rows each with 9 pixel fields
Type 701513 (format 108Q)	2 rows each with 8 pixel fields
Type 701514 (format 104)	2 rows each with 11 pixel fields
Number of pixels per field	8 x 5
Color	White

Electrical data

Voltage supply	(see nameplate)	
Variant 1	AC 110 to 240 V +10/-15 %, 48 to 63 Hz	
Variant 2	AC/DC 20 to 30V, 48 to 63Hz	
Electrical safety	According to EN 61010, part 1; overvoltage category II to 300 V mains voltage, pollution degree 2	
Protection rating	I with internal isolation from SELV	
Power consumption	For AC 110 to 240 V:	For AC/DC 20 to 30 V:
Type 701510 (format 132)	Max. 3.5 W	Max. 3.0 W
Type 701511 (format 116)	Max. 4.1 W	Max. 3.7 W
Types 701512, 701513 (formats 108H, 108Q)	Max. 5.8 W	Max. 5.7 W
Type 701514 (format 104)	Max. 6.6 W	Max. 6.7 W
Electrical connection	On the back via spring-cage terminals (Push-In technology)	
Conductor cross section		
Wire or stranded wire (without ferrule)	Min. 0.2 mm ² , max. 1.5 mm ²	
Stranded wire with ferrule	Without plastic collar: min. 0.2 mm ² , max. 1.5 mm ² With plastic collar: min. 0.2 mm ² , max. 0.75 mm ²	
Stripping length	8 mm	

Environmental influences

Ambient temperature range	
Storage	-30 to +70 °C
Operation	-10 to +55 °C
Site altitude	Max. 2000 m above sea level
Climatic environmental influences	According to DIN EN 60721-3 with extended temperature range
Resistance to climatic conditions	≤ 90 % rel. humidity without condensation
Storage	According to class 1K2
Operation	According to class 3K3

JUMO GmbH & Co. KG
 Delivery address: Mackenrodtstraße 14
 36039 Fulda, Germany
 Postal address: 36035 Fulda, Germany
 Phone: +49 661 6003-0
 Fax: +49 661 6003-607
 Email: mail@jumo.net
 Internet: www.jumo.net

JUMO Instrument Co. Ltd.
 JUMO House
 Temple Bank, Riverway
 Harlow, Essex, CM20 2DY, UK
 Phone: +44 1279 63 55 33
 Fax: +44 1279 62 50 29
 Email: sales@jumo.co.uk
 Internet: www.jumo.co.uk

JUMO Process Control, Inc.
 6724 Joy Road
 East Syracuse, NY 13057, USA
 Phone: +1 315 437 5866
 Fax: +1 315 437 5860
 Email: info.us@jumo.net
 Internet: www.jumousa.com



Mechanical environmental influences	According to DIN EN 60721-3
Storage	According to class 1M2
Transport	According to class 2M2
Operation	According to class 3M3
Electromagnetic compatibility (EMC)	According to DIN EN 61326-1
Interference emission	Class A – only for industrial use –
Interference immunity	Industrial requirements

Case

Case type	Plastic housing for panel mounting according to DIN IEC 61554 (indoor use)
Case front	Made of plastic with membrane keyboard
Panel thickness	1 to 10 mm
Case fastening	In panel using the supplied mounting frame or both mounting elements
Operating position	Any ^a
Protection type	According to DIN EN 60529, IP65 on the front, IP20 on the back
Weight	
Type 701510 (format 132)	Max. 85 g
Type 701511 (format 116)	Max. 120 g
Type 701512 (format 108H)	Max. 160 g
Type 701513 (format 108Q)	Max. 160 g
Type 701514 (format 104)	Max. 220 g

^a The maximum admissible ambient temperature only applies for the installation with the display in a vertical position.

Approvals and approval marks

Approval mark	Test facility	Certificate/certification numbers	Inspection basis	Valid for
c UL us	Underwriters Laboratories	E201387	UL 61010-1 (3. Ed.), CAN/CSA-22.2 No. 61010-1 (3. Ed.)	All types
DNV GL	DNV GL	TAA00001B3	Class Guideline DNVGL-CG-0339	Type 701511 (DC 20 to 30 V) and type 701514 (AC 110 to 240 V), without Ethernet interface, panel mounting
BUREAU VERITAS	Bureau Veritas	53627/A0 BV	Bureau Veritas Rules for the Classification of Steel Ships	

The device is approved if the relevant approval mark is shown on the device.

JUMO GmbH & Co. KG
 Delivery address: Mackenrodtstraße 14
 36039 Fulda, Germany
 Postal address: 36035 Fulda, Germany
 Phone: +49 661 6003-0
 Fax: +49 661 6003-607
 Email: mail@jumo.net
 Internet: www.jumo.net

JUMO Instrument Co. Ltd.
 JUMO House
 Temple Bank, Riverway
 Harlow, Essex, CM20 2DY, UK
 Phone: +44 1279 63 55 33
 Fax: +44 1279 62 50 29
 Email: sales@jumo.co.uk
 Internet: www.jumo.co.uk

JUMO Process Control, Inc.
 6724 Joy Road
 East Syracuse, NY 13057, USA
 Phone: +1 315 437 5866
 Fax: +1 315 437 5860
 Email: info.us@jumo.net
 Internet: www.jumousa.com



Dimensions

Type 701510 (format 132: 48 mm × 24 mm)

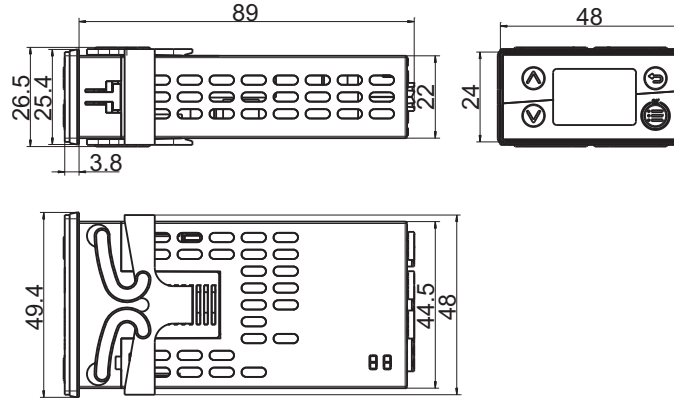

Type 701511 (format 116: 48 mm × 48 mm)

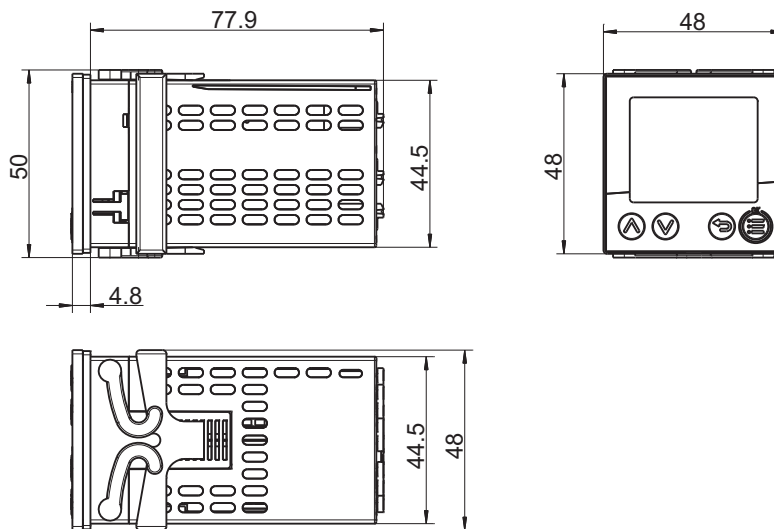

JUMO GmbH & Co. KG
 Delivery address: Mackenrodtstraße 14
 36039 Fulda, Germany
 Postal address: 36035 Fulda, Germany
 Phone: +49 661 6003-0
 Fax: +49 661 6003-607
 Email: mail@jumo.net
 Internet: www.jumo.net

JUMO Instrument Co. Ltd.
 JUMO House
 Temple Bank, Riverway
 Harlow, Essex, CM20 2DY, UK
 Phone: +44 1279 63 55 33
 Fax: +44 1279 62 50 29
 Email: sales@jumo.co.uk
 Internet: www.jumo.co.uk

JUMO Process Control, Inc.
 6724 Joy Road
 East Syracuse, NY 13057, USA
 Phone: +1 315 437 5866
 Fax: +1 315 437 5860
 Email: info.us@jumo.net
 Internet: www.jumousa.com



Type 701512 (format 108H: 48 mm × 96 mm)

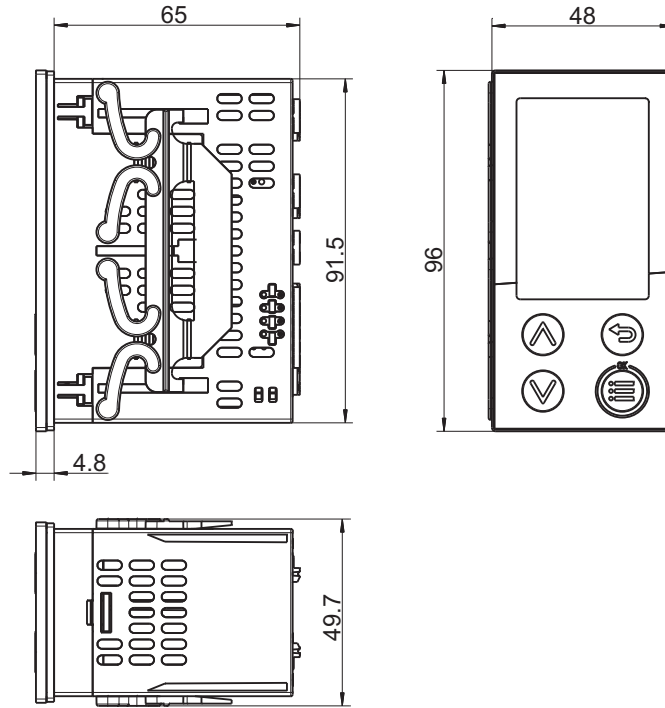

Type 701513 (format 108Q: 96 mm × 48 mm)

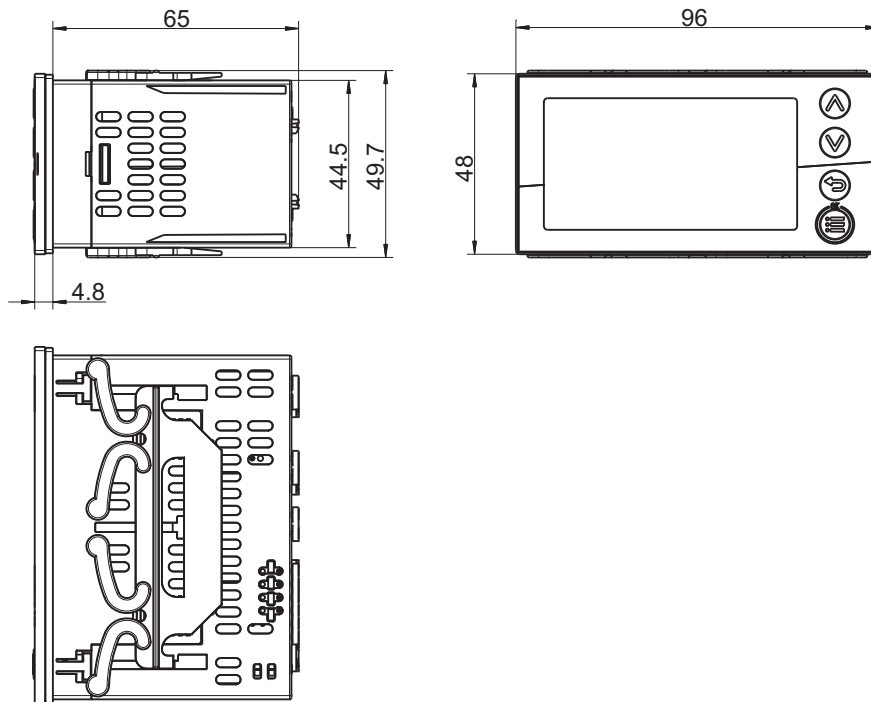

JUMO GmbH & Co. KG
 Delivery address: Mackenrodtstraße 14
 36039 Fulda, Germany
 Postal address: 36035 Fulda, Germany
 Phone: +49 661 6003-0
 Fax: +49 661 6003-607
 Email: mail@jumo.net
 Internet: www.jumo.net

JUMO Instrument Co. Ltd.
 JUMO House
 Temple Bank, Riverway
 Harlow, Essex, CM20 2DY, UK
 Phone: +44 1279 63 55 33
 Fax: +44 1279 62 50 29
 Email: sales@jumo.co.uk
 Internet: www.jumo.co.uk

JUMO Process Control, Inc.
 6724 Joy Road
 East Syracuse, NY 13057, USA
 Phone: +1 315 437 5866
 Fax: +1 315 437 5860
 Email: info.us@jumo.net
 Internet: www.jumousa.com



Type 701514 (format 104: 96 mm × 96 mm)

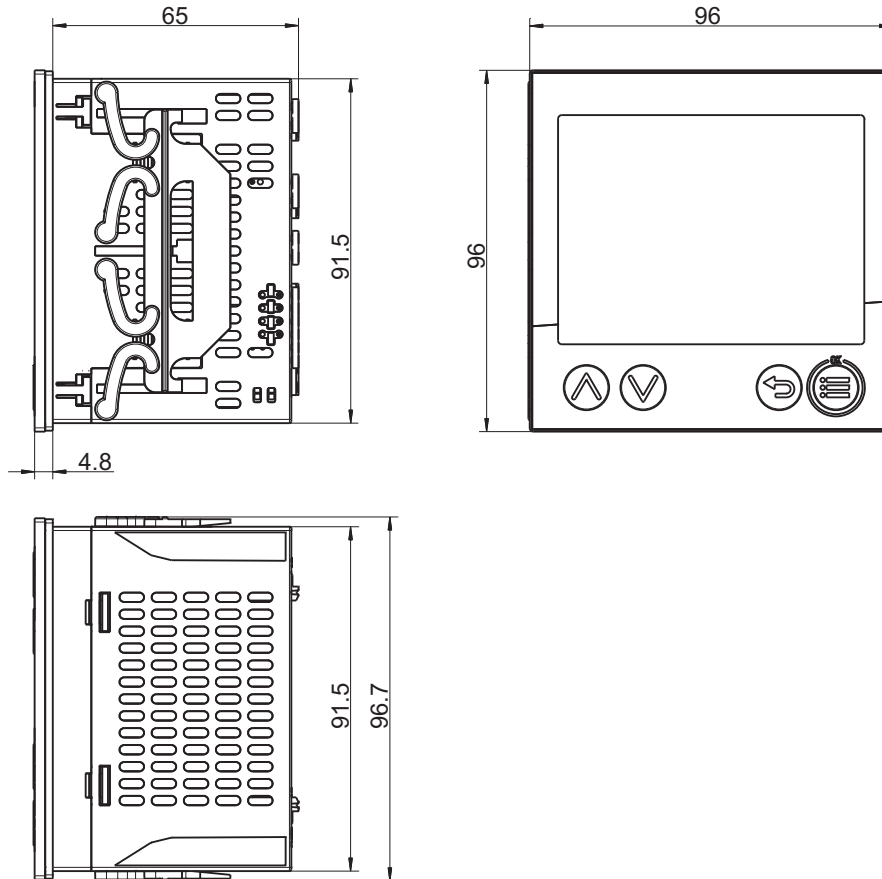

Panel cut-out according to DIN IEC 61554

Type (format; front frame dimensions)	Panel cut-out (width x height)	Minimum spacing of panel cut-outs (for tightly packed installations)	
		Horizontal	Vertical
701510 (132; 48 mm × 24 mm)	45 ^{+0.6} mm × 22.2 ^{+0.3} mm	15 mm	30 mm
701511 (116; 48 mm × 48 mm)	45 ^{+0.6} mm × 45 ^{+0.6} mm	15 mm	30 mm
701512 (108H; 48 mm × 96 mm)	45 ^{+0.6} mm × 92 ^{+0.8} mm	20 mm	30 mm
701513 (108Q; 96 mm × 48 mm)	92 ^{+0.8} mm × 45 ^{+0.6} mm	20 mm	30 mm
701514 (104; 96 mm × 96 mm)	92 ^{+0.8} mm × 92 ^{+0.8} mm	20 mm	30 mm

JUMO GmbH & Co. KG
 Delivery address: Mackenrodtstraße 14
 36039 Fulda, Germany
 Postal address: 36035 Fulda, Germany
 Phone: +49 661 6003-0
 Fax: +49 661 6003-607
 Email: mail@jumo.net
 Internet: www.jumo.net

JUMO Instrument Co. Ltd.
 JUMO House
 Temple Bank, Riverway
 Harlow, Essex, CM20 2DY, UK
 Phone: +44 1279 63 55 33
 Fax: +44 1279 62 50 29
 Email: sales@jumo.co.uk
 Internet: www.jumo.co.uk

JUMO Process Control, Inc.
 6724 Joy Road
 East Syracuse, NY 13057, USA
 Phone: +1 315 437 5866
 Fax: +1 315 437 5860
 Email: info.us@jumo.net
 Internet: www.jumousa.com



Type 701510 (format 132) mounted on DIN rail (see accessories)

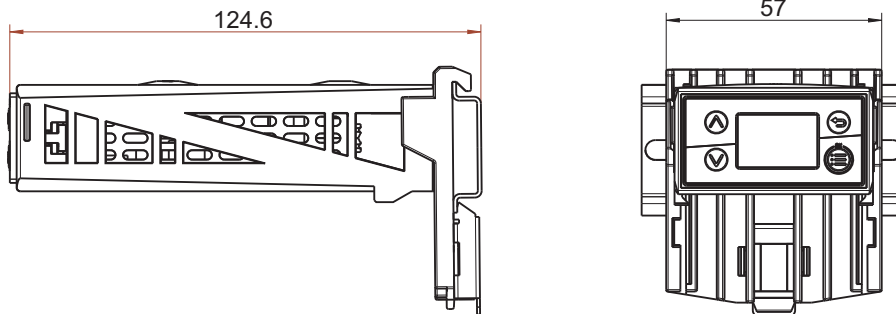

Type 701511 (format 116) mounted on DIN rail (see accessories)

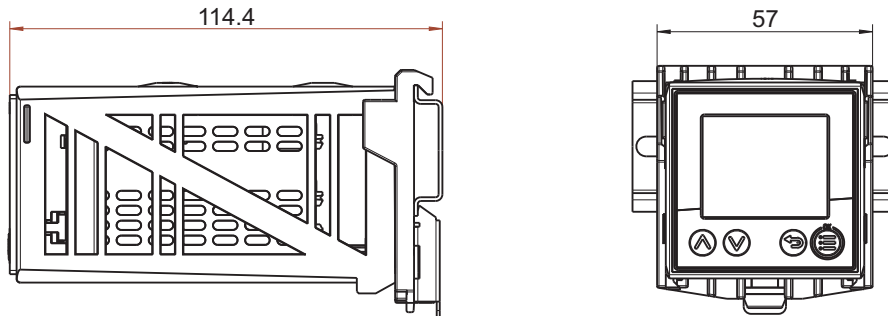

Galvanic isolation

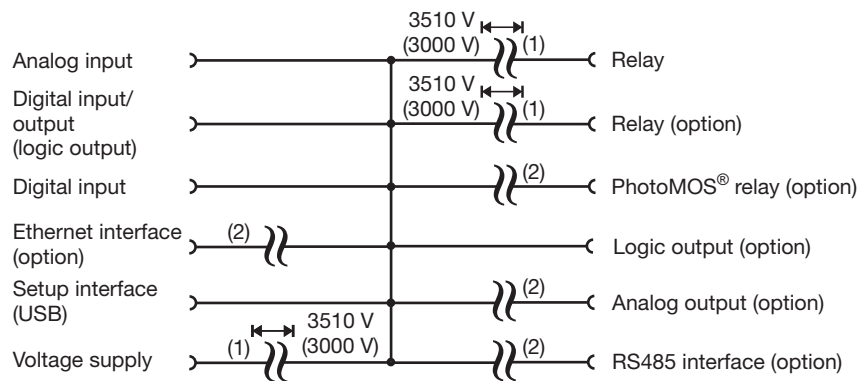

- 1 The voltage specifications correspond to the test voltages (alternating voltage, rms values) according to EN 61010-1:2011-07 for the type test. Type 701510 (format 132): 3000 V instead of 3510 V.
- 2 Functional galvanic isolation for the connection of SELV or PELV circuits.

JUMO GmbH & Co. KG
Delivery address: Mackenrodtstraße 14
36039 Fulda, Germany
Postal address: 36035 Fulda, Germany
Phone: +49 661 6003-0
Fax: +49 661 6003-607
Email: mail@jumo.net
Internet: www.jumo.net

JUMO Instrument Co. Ltd.
JUMO House
Temple Bank, Riverway
Harlow, Essex, CM20 2DY, UK
Phone: +44 1279 63 55 33
Fax: +44 1279 62 50 29
Email: sales@jumo.co.uk
Internet: www.jumo.co.uk

JUMO Process Control, Inc.
6724 Joy Road
East Syracuse, NY 13057, USA
Phone: +1 315 437 5866
Fax: +1 315 437 5860
Email: info.us@jumo.net
Internet: www.jumousa.com



Display and control elements

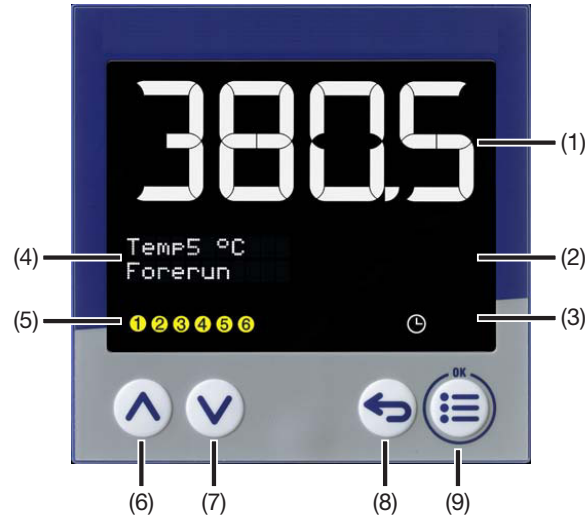

- 1 18-segment LCD display (e.g. measured value), 4-digit, white;
for types 701510 (132) and 701511 (116) also for displaying menu items, parameters and text
- 2 18-segment LCD display (e.g. timer remaining running time), 4-digit (701510 (132): 5-digit, 701511 (116): 8-digit), green;
for types 701510 (132) and 701511 (116) also for displaying menu items, parameters, values and text;
display "OK" when exiting editing mode (with change)
- 3 Activity display for timer
- 4 For types 701512 (108H), 701513 (108Q), and 701514 (104): pixel matrix LCD display for displaying menu items, parameters and values as well as customer-specific text
- 5 Switching of the digital outputs (yellow = active)
- 6 Up (in the menu: increase value, select previous menu item or parameter)
- 7 Down (in menu: reduce value, select next menu item or parameter)
- 8 Back (in menu: back to previous menu level, exit editing mode without change; in basic status: configurable function)
- 9 Menu/OK (call up main menu, switch to submenu/level, switch to editing mode, exit editing mode with change)

JUMO GmbH & Co. KG
 Delivery address: Mackenrodtstraße 14
 36039 Fulda, Germany
 Postal address: 36035 Fulda, Germany
 Phone: +49 661 6003-0
 Fax: +49 661 6003-607
 Email: mail@jumo.net
 Internet: www.jumo.net

JUMO Instrument Co. Ltd.
 JUMO House
 Temple Bank, Riverway
 Harlow, Essex, CM20 2DY, UK
 Phone: +44 1279 63 55 33
 Fax: +44 1279 62 50 29
 Email: sales@jumo.co.uk
 Internet: www.jumo.co.uk

JUMO Process Control, Inc.
 6724 Joy Road
 East Syracuse, NY 13057, USA
 Phone: +1 315 437 5866
 Fax: +1 315 437 5860
 Email: info.us@jumo.net
 Internet: www.jumousa.com



Connection elements

Type 701510 (format 132)

Type 701510 (48 mm × 24 mm)

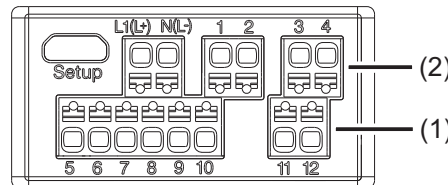

Terminals	Connection	Terminals	Connection	Terminals	Connection
1, 2	Output 1 (relay)	8, 10	Input 2 (for potential-free contact)	L1(L+), N(L-)	Voltage supply
3, 4	(2) = option 2: output 2 (relay, logic or analog output)	9, 10	Input 1 (for potential-free contact) or output 3 (logic output)	Setup (USB)	PC (setup program)
5-8	Analog input	11, 12	(1) = option 1: RS485 interface		

Type 701511 (format 116)

Type 701511 (48 mm × 48 mm)

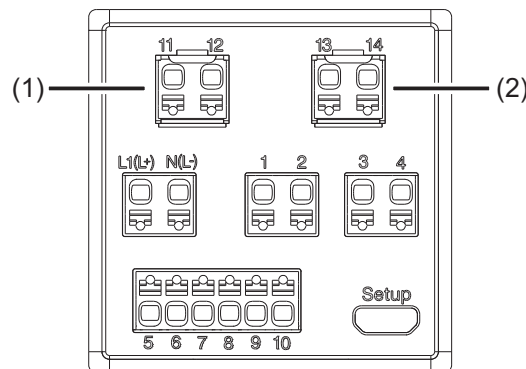

Terminals	Connection	Terminals	Connection	Terminals	Connection
1, 2	Output 1 (relay)	8, 10	Input 2 (for potential-free contact)	13, 14	(2) = option 2: output 5 (relay, logic or analog output)
3, 4	Output 2 (relay)	9, 10	Input 1 (for potential-free contact) or output 3 (logic output)	L1(L+), N(L-)	Voltage supply
5-8	Analog input	11, 12	(1) = option 1: output 4 (relay, logic output) or RS485 interface	Setup (USB)	PC (setup program)

JUMO GmbH & Co. KG
 Delivery address: Mackenrodtstraße 14
 36039 Fulda, Germany
 Postal address: 36035 Fulda, Germany
 Phone: +49 661 6003-0
 Fax: +49 661 6003-607
 Email: mail@jumo.net
 Internet: www.jumo.net

JUMO Instrument Co. Ltd.
 JUMO House
 Temple Bank, Riverway
 Harlow, Essex, CM20 2DY, UK
 Phone: +44 1279 63 55 33
 Fax: +44 1279 62 50 29
 Email: sales@jumo.co.uk
 Internet: www.jumo.co.uk

JUMO Process Control, Inc.
 6724 Joy Road
 East Syracuse, NY 13057, USA
 Phone: +1 315 437 5866
 Fax: +1 315 437 5860
 Email: info.us@jumo.net
 Internet: www.jumousa.com



Types 701512 (format 108H), 701513 (format 108Q), 701514 (format 104)

If the device is equipped with the Ethernet interface (option 2: RJ45 socket), terminals 11 to 14 are not available.

Type 701513 (96 mm × 48 mm)

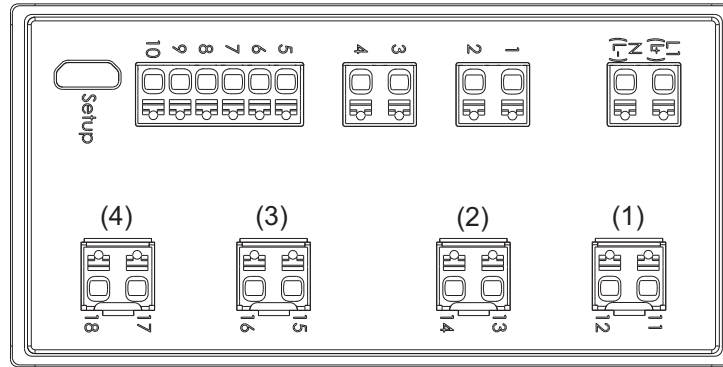

Type 701512 (48 mm × 96 mm)

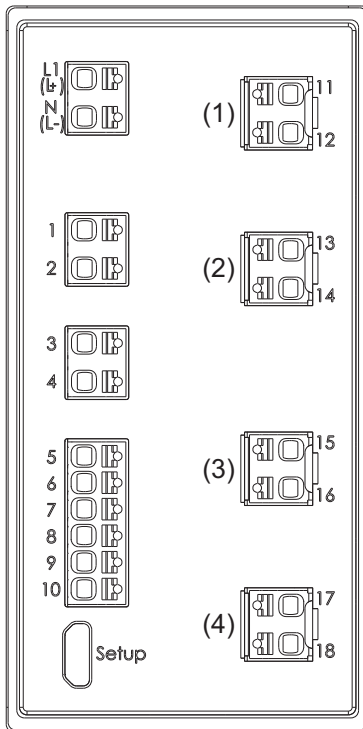

Type 701514 (96 mm × 96 mm)

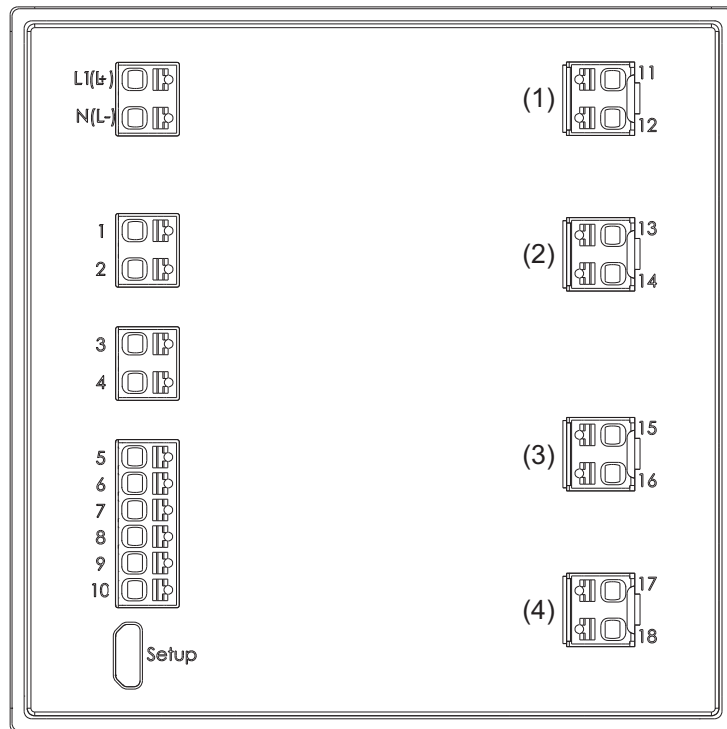

Terminals	Connection
1, 2	Output 1 (relay)
3, 4	Output 2 (relay)
5-8	Analog input
8, 10	Input 2 (for potential-free contact)

Terminals	Connection
9, 10	Input 1 (for potential-free contact) or output 3 (logic output)
11, 12	(1) = option 1: output 4 (logic output) or RS485 interface
13, 14	(2) = option 2: output 5 (relay, logic or analog output)
15, 16	(3) = option 3: output 6 (relay, logic output or PhotoMOS® relay)

Terminals	Connection
17, 18	(4) = option 4: output 7 (relay, logic output or PhotoMOS® relay)
L1(L+), N(L-)	Voltage supply
Setup (USB)	PC (setup program)



Connection diagram

The connection diagram in the data sheet provides information on product selection.

For the electrical connection, only use the installation instructions or the operating manual.

Analog input

The analog input version is identical for all types.

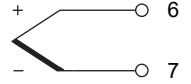
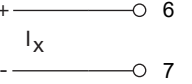
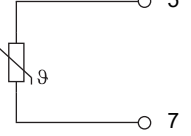
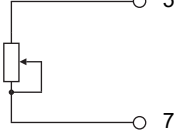
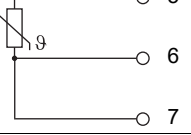
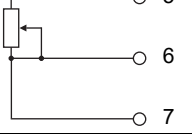
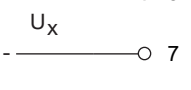
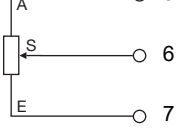
Measuring probe/ standard signal	Symbol and terminal designation	Measuring probe/ standard signal	Symbol and terminal designation
Thermocouple		Current DC 0(4) ... 20 mA	
RTD temperature probe two-wire circuit		Resistance/potentiometer two-wire circuit	
RTD temperature probe three-wire circuit		Resistance/potentiometer three-wire circuit	
Voltage DC 0(2) ... 10 V (useable as alternative to digital input 2)		Resistance transmitter	

A = Start
E = End
S = Slider

Digital inputs

The digital input version is identical for all types.

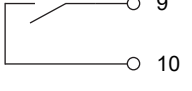
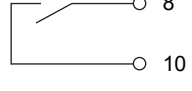
Input	Version	Symbol and terminal designation	Input	Version	Symbol and terminal designation
1	Digital input for potential-free contact (useable as alternative to digital output 3)		2	Digital input for potential-free contact (only usable if the analog input is not configured as DC 0(2) ... 10 V)	

Analog output

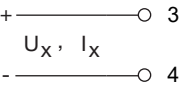
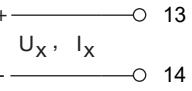
Version for type 701510 (format 132)			Version for types 701511 to 701514		
Output		Symbol and terminal designation	Output		Symbol and terminal designation
2	Option 2 (alternative to digital output 2): DC 0/2 ... 10 V or DC 0/4 ... 20 mA (configu- rable)		5	Option 2 (alternative to digital output 5): DC 0/2 ... 10 V or DC 0/4 ... 20 mA (configu- rable)	

JUMO GmbH & Co. KG
 Delivery address: Mackenrodtstraße 14
 36039 Fulda, Germany
 Postal address: 36035 Fulda, Germany
 Phone: +49 661 6003-0
 Fax: +49 661 6003-607
 Email: mail@jumo.net
 Internet: www.jumo.net

JUMO Instrument Co. Ltd.
 JUMO House
 Temple Bank, Riverway
 Harlow, Essex, CM20 2DY, UK
 Phone: +44 1279 63 55 33
 Fax: +44 1279 62 50 29
 Email: sales@jumo.co.uk
 Internet: www.jumo.co.uk

JUMO Process Control, Inc.
 6724 Joy Road
 East Syracuse, NY 13057, USA
 Phone: +1 315 437 5866
 Fax: +1 315 437 5860
 Email: info.us@jumo.net
 Internet: www.jumousa.com



Digital outputs

Output	Version	Symbol and terminal designation	Output	Version	Symbol and terminal designation
1	Relay (N/O contact)	1 2	5	Option 2 for types 701511 (116) , 701512 (108H) , 701513 (108Q) , and 701514 (104) (alternative to analog output): Relay (N/O contact) or logic output 0/14 V	13 14 + — 13 - — 14
2	Relay (N/O contact), (for type 701510 as option 2, see below) Option 2 for type 701510 (132) (alternative to analog output): Relay (N/O contact) or logic output 0/14 V	3 4 + — 3 - — 4	6	Option 3 for types 701512 (108H) , 701513 (108Q) , and 701514 (104) : Relay (N/O contact) or logic output 0/14 V or PhotoMOS [®] relay	15 16 + — 15 - — 16
3	Logic output 0/14 V (usable as alternative to digital input 1)	+ — 9 - — 10	7	Option 4 for types 701512 (108H) , 701513 (108Q) , and 701514 (104) : Relay (N/O contact; only with longer contact life) or logic output 0/14 V or PhotoMOS [®] relay	17 18 + — 17 - — 18
4	Option 1 for types 701511 (116) , 701512 (108H) , 701513 (108Q) , and 701514 (104) (alternative to RS485 interface): Relay (N/O contact), only for type 701511 (116) or logic output 0/14 V	11 12 + — 11 - — 12			

RS485 interface

Version for type 701510 (format 132)	Symbol and terminal designation	Version for types 701511 to 701514	Symbol and terminal designation
Option 1: RS485 interface	RxD/TxD+ —○ 11 RxD/TxD- —○ 12	Option 1 (alternative to digital output 4): RS485 interface	RxD/TxD+ —○ 11 RxD/TxD- —○ 12

Voltage supply

Version (see nameplate)	Symbol and terminal designation	Version (see nameplate)	Symbol and terminal designation
AC 110 to 240 V	L1 —○ L1/L+ N —○ N/L-	AC/DC 20 to 30 V	L+ —○ L1/L+ L- —○ N/L-

JUMO GmbH & Co. KG
 Delivery address: Mackenrodtstraße 14
 36039 Fulda, Germany
 Postal address: 36035 Fulda, Germany
 Phone: +49 661 6003-0
 Fax: +49 661 6003-607
 Email: mail@jumo.net
 Internet: www.jumo.net

JUMO Instrument Co. Ltd.
 JUMO House
 Temple Bank, Riverway
 Harlow, Essex, CM20 2DY, UK
 Phone: +44 1279 63 55 33
 Fax: +44 1279 62 50 29
 Email: sales@jumo.co.uk
 Internet: www.jumo.co.uk

JUMO Process Control, Inc.
 6724 Joy Road
 East Syracuse, NY 13057, USA
 Phone: +1 315 437 5866
 Fax: +1 315 437 5860
 Email: info.us@jumo.net
 Internet: www.jumousa.com



Order details

(1) Basic type	
701510	Type 701510 (format 132: 48 x 24 mm) 1 analog input, 2 digital inputs (digital input 1, alternative to logic output), 1 relay (N/O contact), 1 logic output 0/14 V (alternative to digital input 1) incl. timer, min/max value display, hold function, taring function
701511	Type 701511 (format 116: 48 x 48 mm) 1 analog input, 2 digital inputs (digital input 1, alternative to logic output), 2 relays (N/O contact), 1 logic output 0/14 V (alternative to digital input 1) incl. timer, min/max value display, hold function, taring function
701512	Type 701512 (format 108H: 48 x 96 mm) 1 analog input, 2 digital inputs (digital input 1, alternative to logic output), 2 relays (N/O contact), 1 logic output 0/14 V (alternative to digital input 1) incl. timer, min/max value display, hold function, taring function
701513	Type 701513 (format 108Q: 96 x 48 mm) 1 analog input, 2 digital inputs (digital input 1, alternative to logic output), 2 relays (N/O contact), 1 logic output 0/14 V (alternative to digital input 1) incl. timer, min/max value display, hold function, taring function
701514	Type 701514 (format 104: 96 x 96 mm) 1 analog input, 2 digital inputs (digital input 1, alternative to logic output), 2 relays (N/O contact), 1 logic output 0/14 V (alternative to digital input 1) incl. timer, min/max value display, hold function, taring function
(2) Version	
8	Standard with default settings ^a
9	Customer-specific configuration (specifications in plain text)
(3) Option 1^b	
0	Not used
1	1 relay (N/O contact) (only for type 701511)
2	1 logic output 0/14 V (only for types 701511, 701512, 701513, 701514)
4	1 RS485 interface (Modbus-RTU)
(4) Option 2^b	
0	Not used
1	1 relay (N/O contact)
2	1 logic output 0/14 V
3	1 analog output
7	1 Ethernet interface (Modbus-TCP, Modbus-RTU/ASCII via TCP/IP; only for types 701512, 701513, 701514); option 1 does not apply
(5) Option 3^b (only for types 701512, 701513, 701514)	
0	Not used
1	1 relay (N/O contact)
2	1 logic output 0/14 V
5	1 PhotoMOS [®] relay ^c
(6) Option 4^b (only for types 701512, 701513, 701514)	
0	Not used
1	1 relay (N/O contact)
2	1 logic output 0/14 V
5	1 PhotoMOS [®] relay ^c
6	1 relay (N/O contact) with longer contact life

