

N 936.3 SERIES VACUUM PUMPS



N 936.3 ANE

ADVANTAGES

- Optimal flow characteristics for fast drying
- Copes well with vapor and condensation
- Excellent price/performance ratio
- Integrated extended voltage range motor

POSSIBLE AREAS OF USE

- Vacuum drying
- Instrumental analysis – sample preparation
- Medical technology – especially autoclaves

Please visit our website
www.knf.com
to get more information

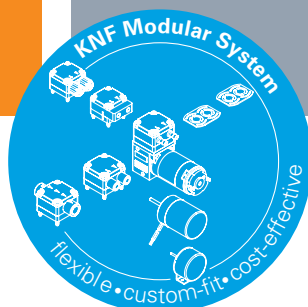

PERFORMANCE DATA

Series model	N 936.3 – 50 Hz Version		N 936.3 – 60 Hz Version	
Material design	ANE			
Pump head	Aluminum			
Diaphragm	HNBR/Stainless steel			
Valves	HNBR			
Flow rate at atm. pressure (l/min)	36.0 ± 10 %		39.0 ± 10 %	
Ultimate vacuum (mbar abs.)	35			
Max. operating pressure (bar rel./psig)	0.5/7.3			
Permissible ambient temperature (°C)	+15 ... +50, intermittent +70			
Permissible media temperature (°C)	+5 ... +70, intermittent +100			
Weight (kg/lbs)	5.2/11.4			

ELECTRICAL DATA

Voltage (V)	100–120		200–240	
	Motor			
Motor	Capacitor motor			
Protection class motor	IP 00			
Frequency (Hz)	50		60	
Power P ₁ (W)	190			
I _{max} (A)	2.30	1.30	1.80	1.00

N 936.3 ANE – 50 HZ VERSION

PERFORMANCE DATA

Series model	Flow rate at atm. pressure (l/min)	Max. operating pressure (bar rel./psig)	Ultimate vacuum (mbar abs.)
N 936.3 ANE	36.0 ± 10 %	0.5/7.3	35

Flow rate determined at 20 °C, 1013 mbar abs.
(Pressure 0 to 1013 mbar abs. in accordance with ISO 21360-1/2)

N 936.3 ANE

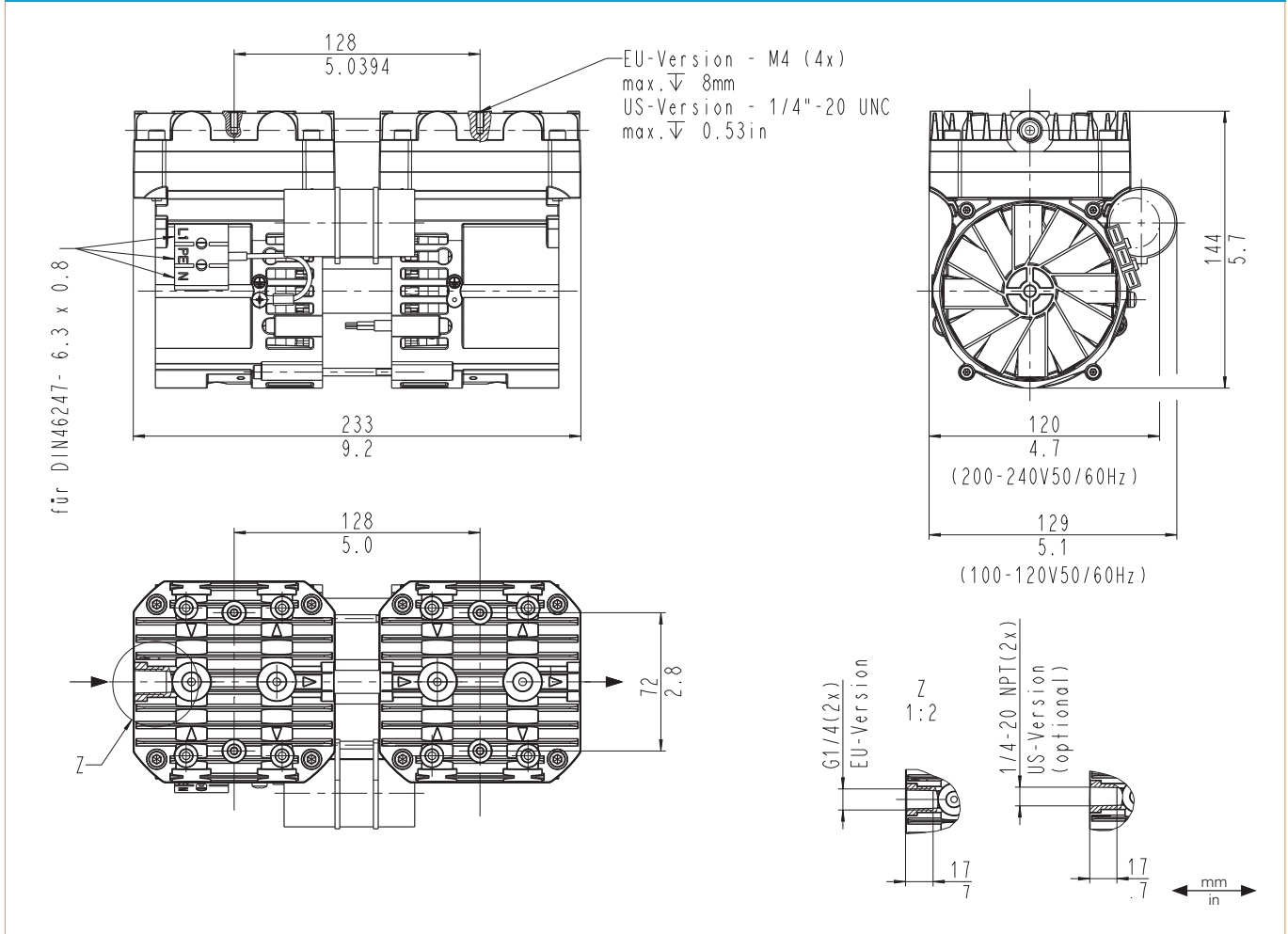

N 936.3 ANE – 50 HZ VERSION

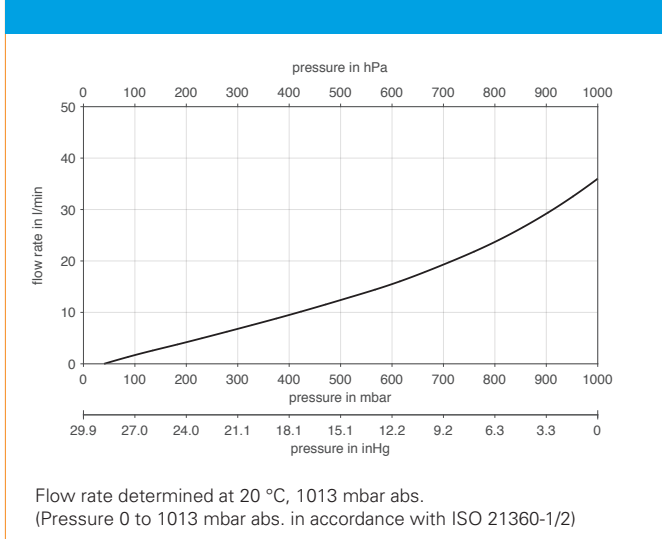

N 936.3 ANE – 50 HZ VERSION | PUMP DOWN TIME FOR 20 LITER VESSEL

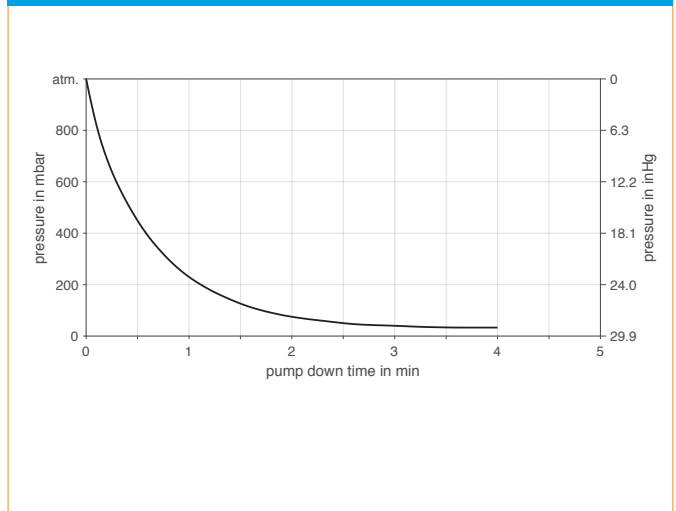

N 936.3 ANE – 60 HZ VERSION

PERFORMANCE DATA

Series model	Flow rate at atm. pressure (l/min)	Max. operating pressure (bar rel./psig)	Ultimate vacuum (mbar abs.)
N 936.3 ANE	39.0 ± 10 %	0.5/7.3	35

Flow rate determined at 20 °C, 1013 mbar abs.
(Pressure 0 to 1013 mbar abs. in accordance with ISO 21360-1/2)

N 936.3 ANE

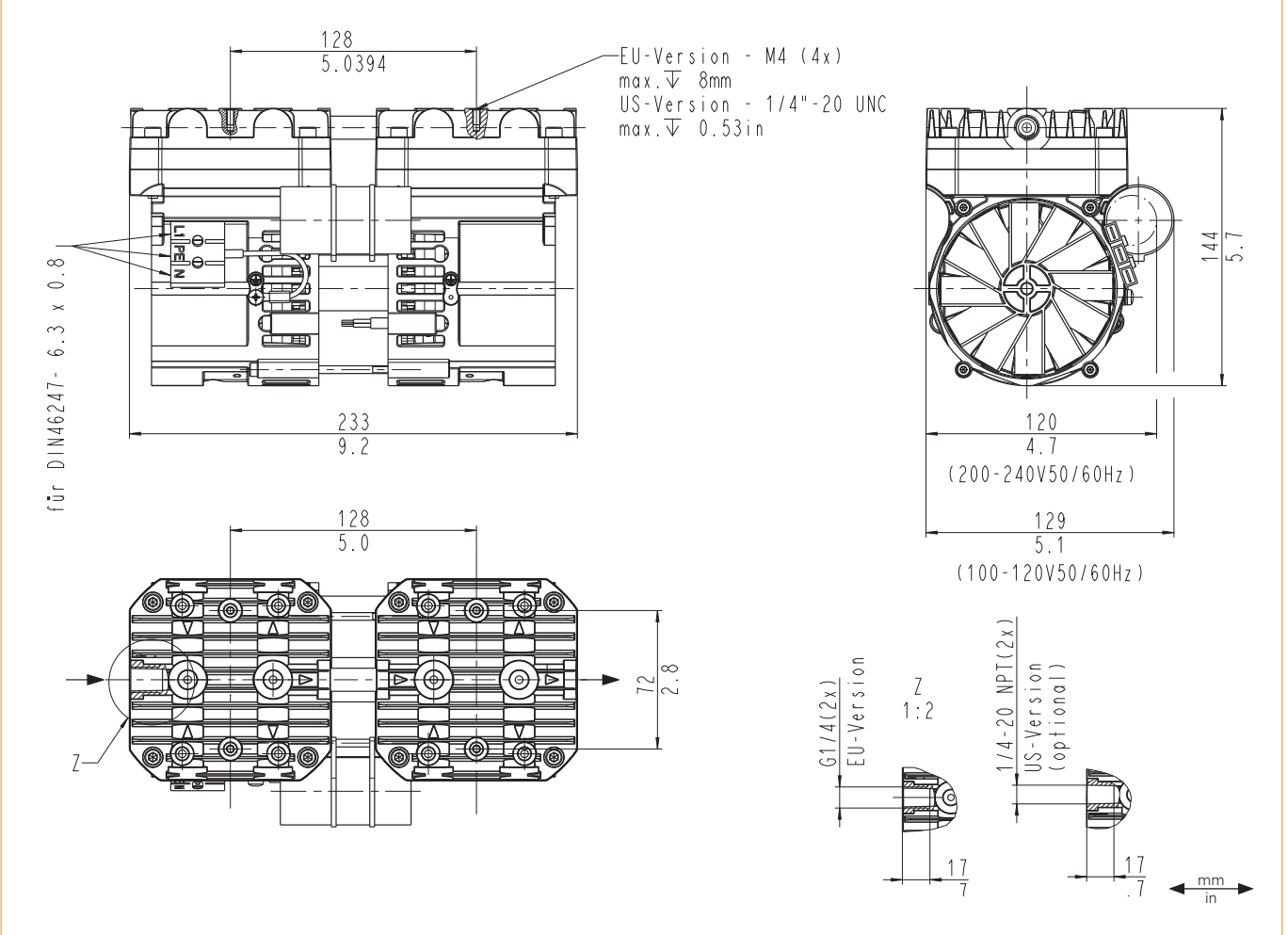

N 936.3 ANE – 60 HZ VERSION

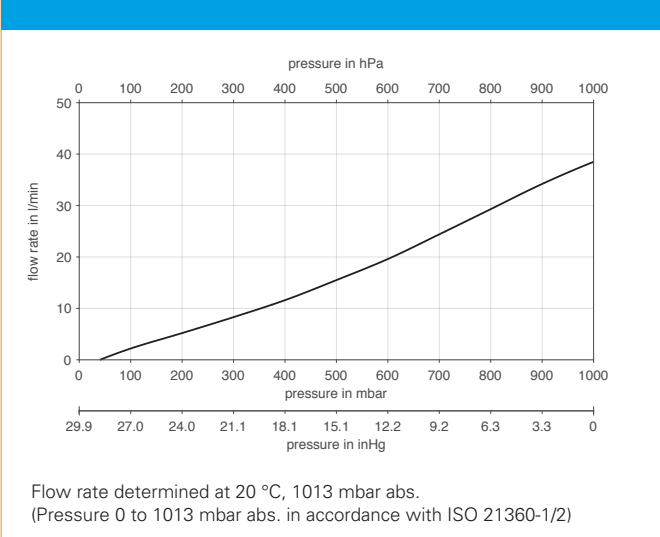

N 936.3 ANE – 60 HZ VERSION | PUMP DOWN TIME FOR 20 LITER VESSEL

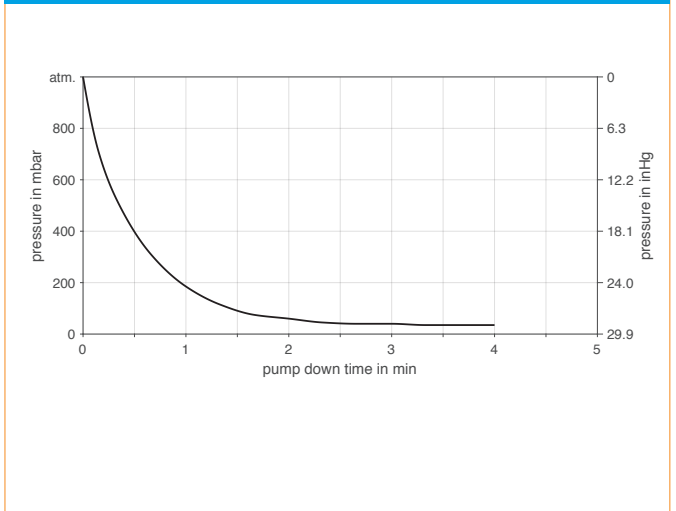

ACCESSORIES

Description	Illustration	Part No.
Foot (2 pcs/pump)		302892
Mounting screw for foot (4 pcs/pump)		110713
Rubber bonded metal, M4 female thread, (4 pcs/pump)		124782
Hose connector Ms G 1/4 for ID 9 mm		004950
Cu sealing		005150

SPARE PARTS

Description	Part No.
Spare parts kit N 936.3 ANE (2 x diaphragm, 4 x valve, 4 x o-ring valve, 2 x o-ring connection, 2 x o-ring below diaphragm, 2 x screw for retainer plate)	306208

The performance values for the series models shown on this data sheet were determined under test conditions. The actual performance values may differ and depend in particular on the usage conditions and therefore on the specific application, on the parameters of the components involved in the user's system and on any technical modifications carried out which deviate from the standard configuration or the as delivered condition.

If individual designs have been created for specific customers on the basis of series models, other technical performance data may apply.

Before operation begins, the relevant operating instructions and/or assembly or installation instructions should be read and the safety information contained in these instructions should be noted.

KNF reserves the right to make changes to the product and the associated documentation without prior notice to the customer.



www.knf.com