

# コンパクトサイズのギアード

## ステッピングモータ STEPPING MOTORS

# SPG33-1000

### ■特長 FEATURES

- 小型のギアヘッド付ステッピングモータ
- コネクタ式のため、アセンブリが容易
- RoHS 指令対応
- Compact stepping motor with gear head
- Provided with connector terminals for easy connection
- RoHS compliant

### ■用途 APPLICATIONS

- ゲーム機器
- その他一般用
- Game machines
- Others

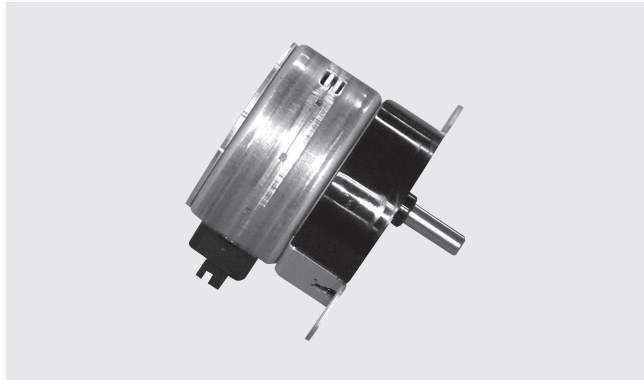

### ■型式表示 PART NUMBER DESIGNATION

SPG 33 - 1 1 0 1

シリーズ名 Series name

固有番号 Dash number

### ■型式一覧表 LIST OF PART NUMBERS

ギア比 Gear ratio	コイル抵抗 Winding resistance	16 Ω	21 Ω	36 Ω
1/2.5	ユニポーラ Unipolar	1000	1001	1002
1/5		1100	1101	1102
1/12		1200	1201	1202

※ご注文に際しては、上記型式をご確認の上、シリーズ名と固有番号を明記して下さい。

※ When ordering, please specify the part number and dash number.

### ■外形寸法図 OUTLINE DIMENSIONS

Unless otherwise specified tolerance: ± 0.5 (Unit: mm)

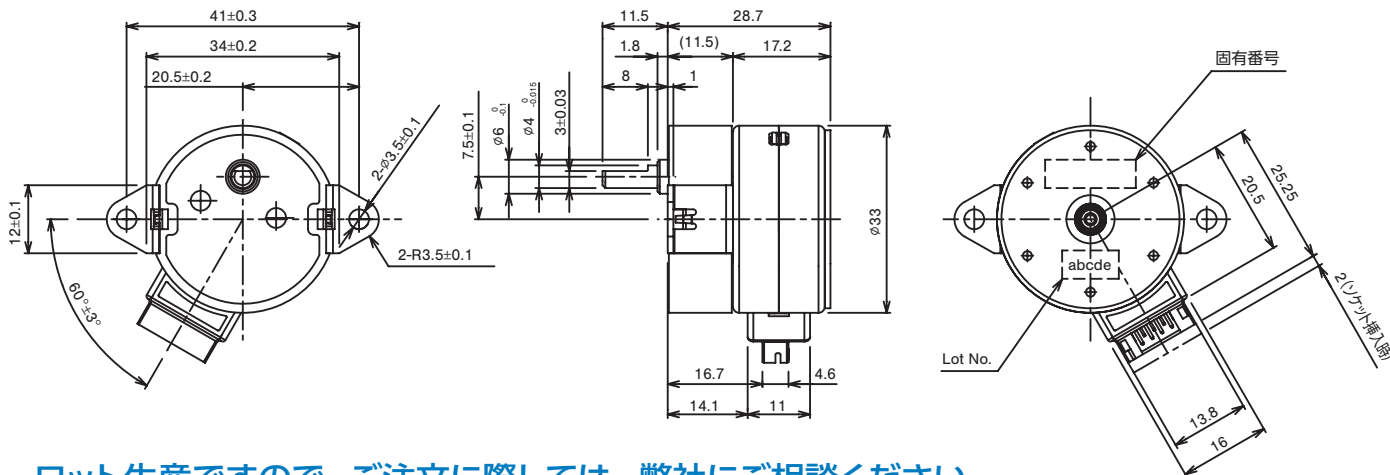

ロット生産ですので、ご注文に際しては、弊社にご相談ください。  
Lot production is required. Please consult us for ordering.

# SPG33-1000

## STEPPING MOTORS

### 標準仕様 STANDARD SPECIFICATIONS

項目 Item	SPG33-1000									
	1000	1100	1200	1001	1101	1201	1002	1102	1202	
相数 Number of phases	4									
極数 Number of poles	12									
励磁方式 Excitation	4相ユニポーラ (コモン端子を開放することにより、2相バイポーラとしても使用できます) 4 phases unipolar(Substitutable as two bipolars due to open common terminal pins.)									
ギア比 Gear ratio	1/2.5	1/5	1/12	1/2.5	1/5	1/12	1/2.5	1/5	1/12	
基本ステップ角度 Basic step angle	6°	3°	1.25°	6°	3°	1.25°	6°	3°	1.25°	
1回転ステップ数 Steps	60	120	288	60	120	288	60	120	288	
コイル抵抗 Winding resistance	16 Ω			21 Ω			36 Ω			
入力定格 Power	平均消費電力 2W 以内 Average power consumption 2 W maximum									
電流 Current	特性図参照 Refer to PERFORMANCE CURVES									
引入トルク Pull-in torque										
脱出トルク Pull-out torque										
自起動周波数 Pull-in pulse rate										
温度上昇 Temperature rise	温度特性図参照 Refer to TEMPERATURE CHARACTERISTICS									
絶縁抵抗 CURVES Insulation resistance	30 MΩ min. (500 VDC)									
絶縁耐力 Dielectric strength	500 Vrms (AC 50 Hz, 1 min)									
使用温度範囲 Operating temperature range	0 ~ 50 °C									
質量 Net weight	Approx. 80 g									
出力軸最大負荷 Axial maximum load	連続 Continuous	9.8 mN-m			19.6 mN-m			39.2 mN-m		
	瞬間 Momentary	19.6 mN-m			39.2 mN-m			98 mN-m		
出力軸形状 Axial shape	D cut									
標準コネクタ端子 Standard connector terminal	<p>相手コネクタ 06CR-6H-P、06KR-6H-Pまたは、PHR-6 日本圧着端子製造 Male connector 06CR-6H-P 06KR-6H-P or PHR-6 Made by J.S.T. Mfg. Co., Ltd</p>									

# SPG33-1000

## STEPPING MOTORS

### 特性図 PERFORMANCE CURVES

12V-2phases-EX.

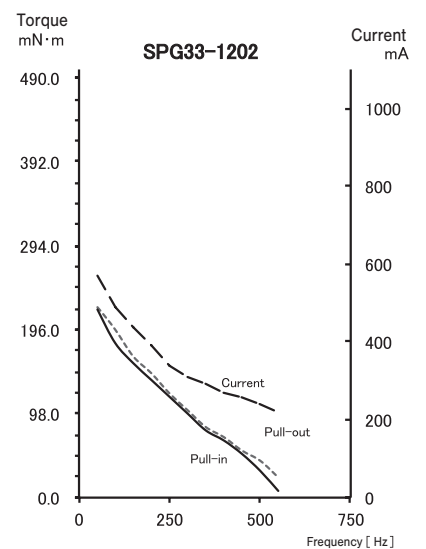
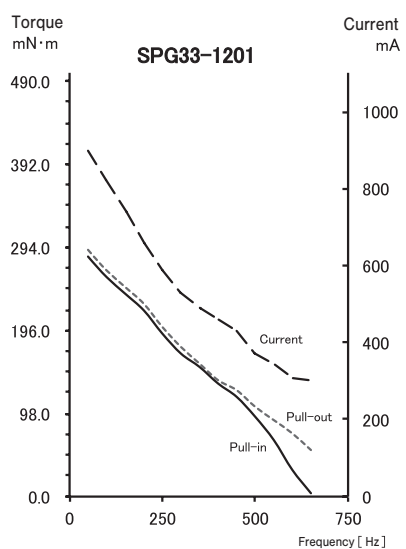
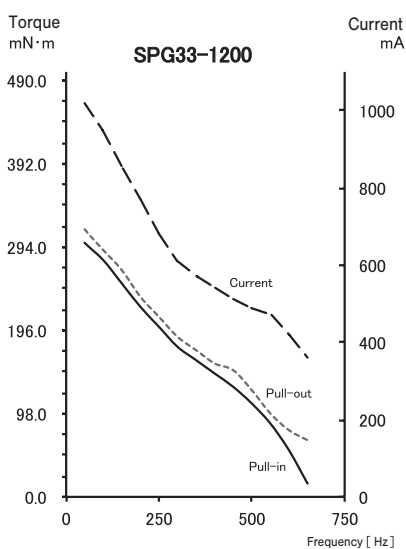
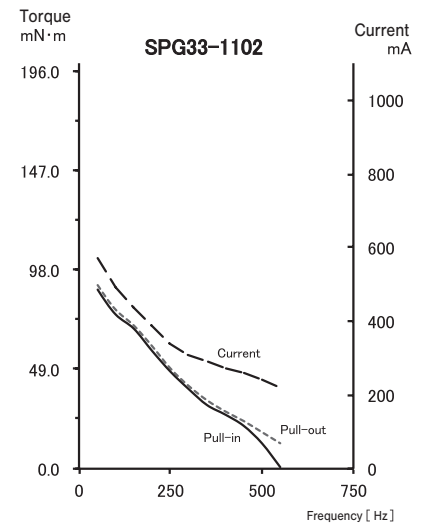
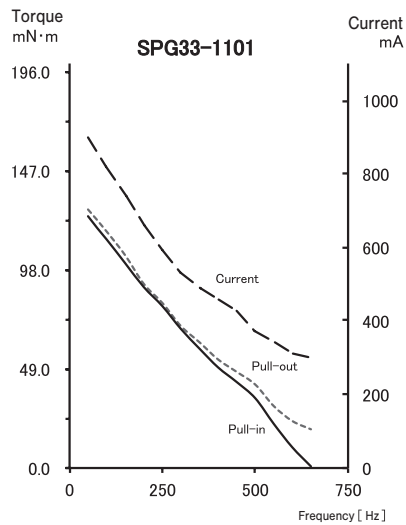
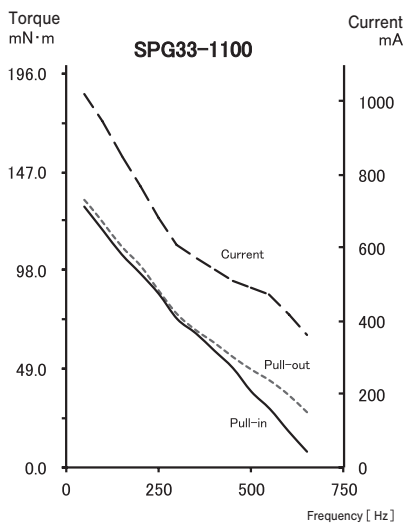
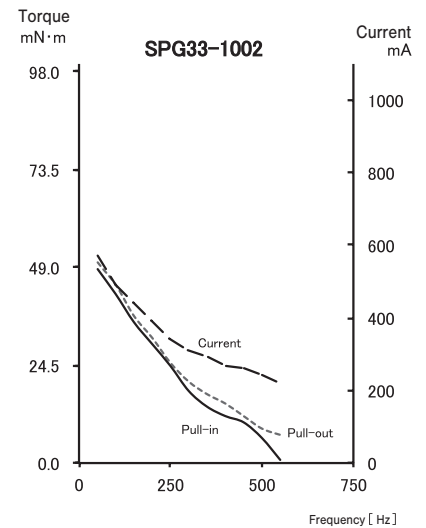
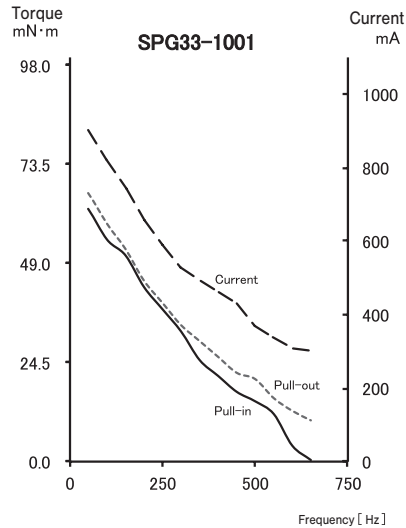
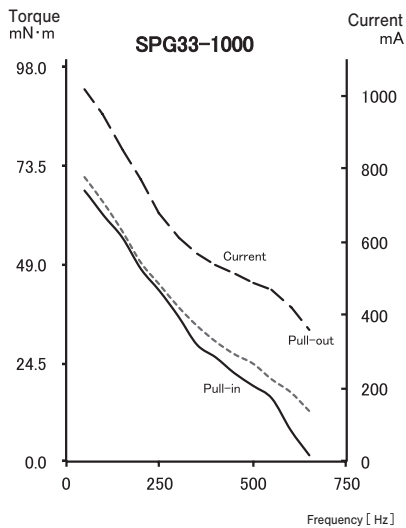

### 温度特性図 (参考値) TEMPERATURE CHARACTERISTICS (REFERENCE VALUE)

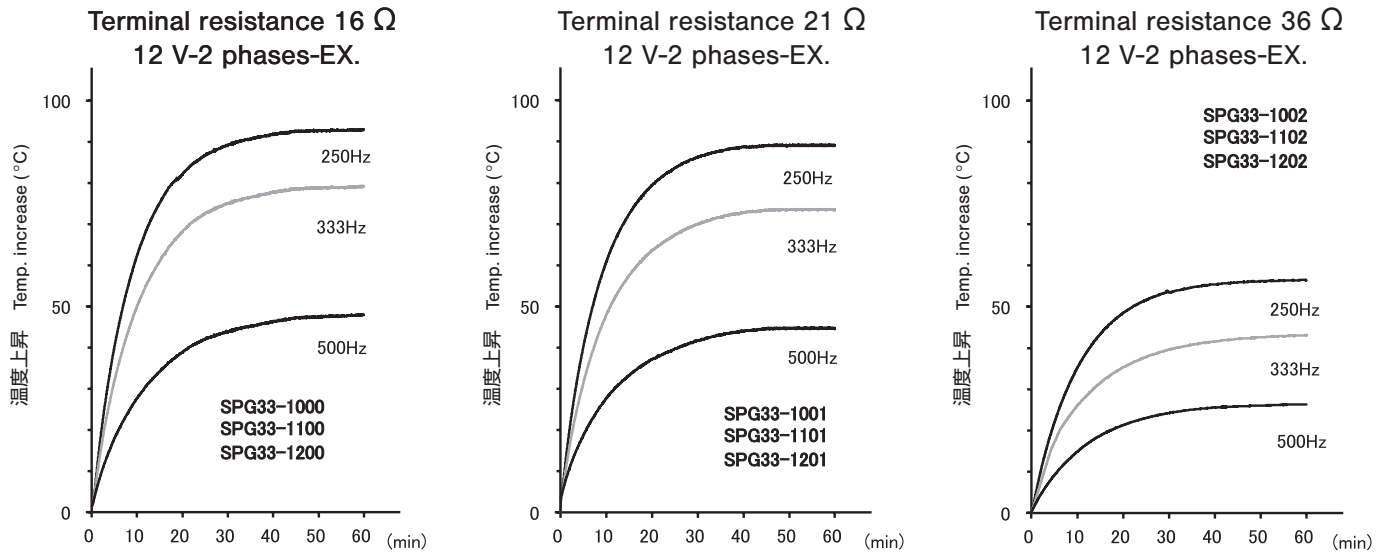

※特性は実測値です。保証値ではありません。  
 These performance curves show actual value, not guaranteed value.